

# ONKYO

# TX-NR646

## AV RECEIVER

## Basic Manual

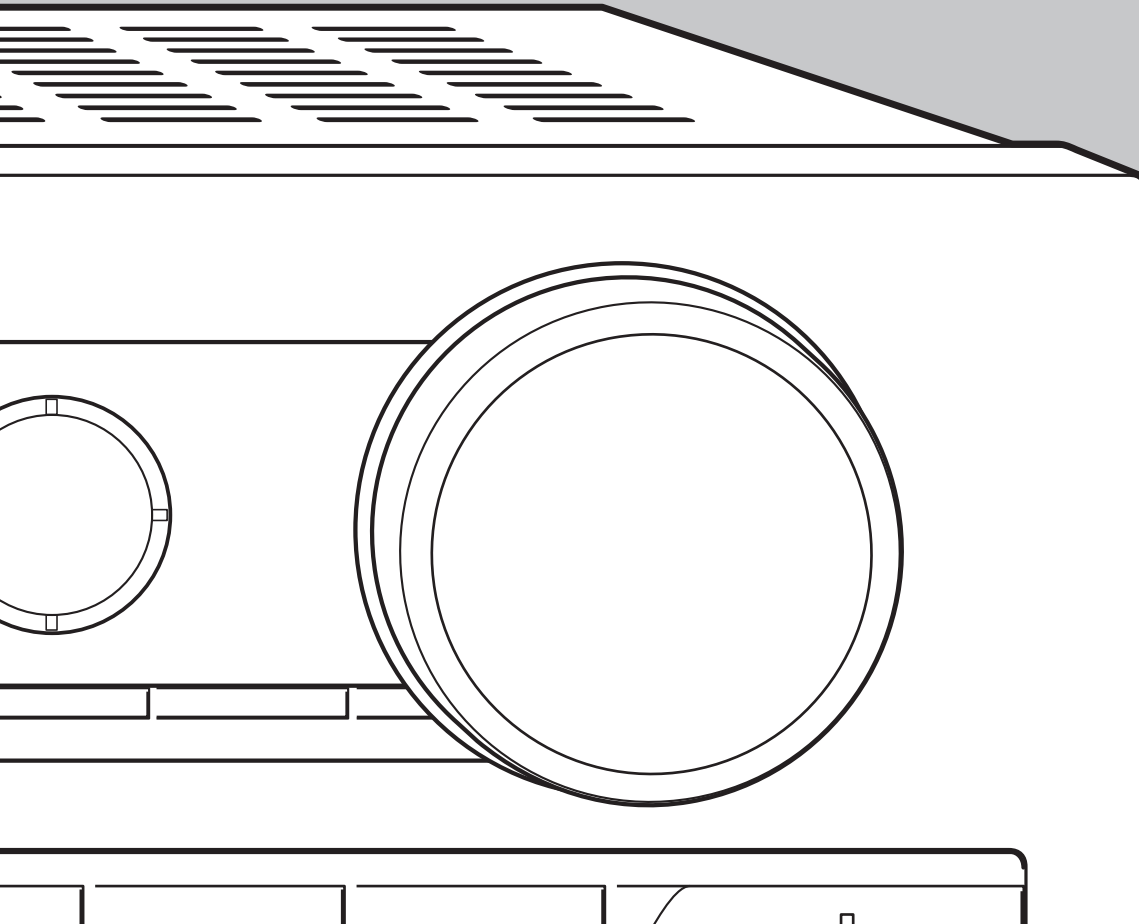

This manual includes information needed when starting up and also instructions for frequently used operations. The Advanced Manual is published on the web for ecological reasons and has more detailed information and advanced settings.

Advanced Manual  
found here



<http://www.onkyo.com/manual/txnr646/adv/en.html>

En

# Features

- Equipped with 7 ch amplifier
- Supports playback in Dolby Atmos format which provides 360-degree placement and movement of sounds including overhead sound
- Supports playback in DTS:X, which is DTS's next-generation object-based surround sound technology that includes height to deliver a fully-immersive listening experience to your living room
- Dolby Surround listening mode expands 2 ch, 5.1 ch or 7.1 ch source to available speaker configurations
- Equipped with 4K compatible HDMI IN/OUT jacks
- Equipped with 2 HDMI output jacks
- Supports the HDMI Standby Through function which allows signal transmission from players to the TV in standby state
- Supports HDCP2.2, a strict copy-protection for providing high quality content (HDMI IN1 to IN3/HDMI OUT MAIN/SUB)
- Supports ARC (Audio Return Channel)
- Supports USB storage playback
- Supports variety of network functions such as Internet Radio, DLNA, AirPlay etc.
- Supports Wi-Fi and Bluetooth®
- Equipped with a PHONO jack enabling connection with a turntable
- Bi-Amping capability
- A/V Sync Function to correct deviation of audio and video
- Multi-zone function which allows you to play a different source in another room from the main room
- 32 bit DSP (Digital Signal Processor) with excellent calculation performance
- Music Optimizer™ for compressed digital music files
- Phase Matching Bass System
- Automatic speaker setup available using supplied calibrated microphone (AccuEQ Room Calibration)
- Supports playback of MP3, WMA, WMA Lossless, FLAC, WAV, Ogg Vorbis, Apple Lossless, DSD, Dolby TrueHD via network and USB storage device (the supported formats will differ depending on the use environment)

Refer to the back cover for supplied accessories.

# Contents

## Basic Manual (this manual)

Front Panel.....	3
Rear Panel.....	4
Display.....	4
<b>Step 1: Connections.....</b>	<b>5</b>
1 Connecting speakers.....	5
• Speaker layout .....	5
• Height speaker types .....	5
• Instructions on how to connect speakers.....	7
2 Connecting the TV and players.....	8
• HDMI cable connection .....	8
• Connecting Components without HDMI .....	9
3 Other connections .....	10
<b>Step 2: Initial Setup .....</b>	<b>11</b>
1 AccuEQ Room Calibration .....	11
2 Source Connection.....	12
3 Remote Mode Setup .....	13
4 Network Connection.....	13
<b>Step 3: Playing Back .....</b>	<b>15</b>
1 Basic Operations .....	15
• Part names and functions of the remote controller .....	15
2 Network Functions.....	16
3 AirPlay® .....	16
4 Bluetooth® .....	17
5 AM/FM Radio .....	17
6 Multi-zone.....	18
• Making Multi-zone Connection.....	18
• Performing Multi-zone Playback .....	19
7 Quick Setup Menu.....	19
8 Other useful functions .....	20
Troubleshooting.....	21
Specifications .....	22
Table of image resolutions.....	23
Resolutions supported by HDMI.....	23
Supplied Accessories .....	Back cover

## Advanced Manual (on the web)

The Advanced Manual, published as an e-manual on the web, has more detailed information and advanced settings. The Advanced Manual is created in a format that makes it easy to read on a PC or Smartphone. The Advanced Manual has the following content:

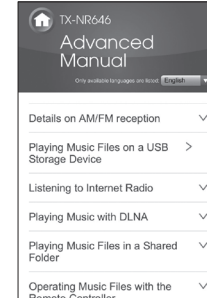

- Details on AM/FM reception
- Playing Music Files on a USB Storage Device
- Listening to Internet Radio
- Playing Music with DLNA
- Playing Music Files in a Shared Folder
- Operating Music Files with the Remote Controller
- Listening Mode
- Advanced Settings
- Operating Other Components with the Remote Controller
- Advanced speaker connections
- Connecting and Operating Onkyo RI Components
- Firmware Update
- Troubleshooting
- Reference Information



Advanced Manual found here  
<http://www.onkyo.com/manual/txnr646/adv/en.html>

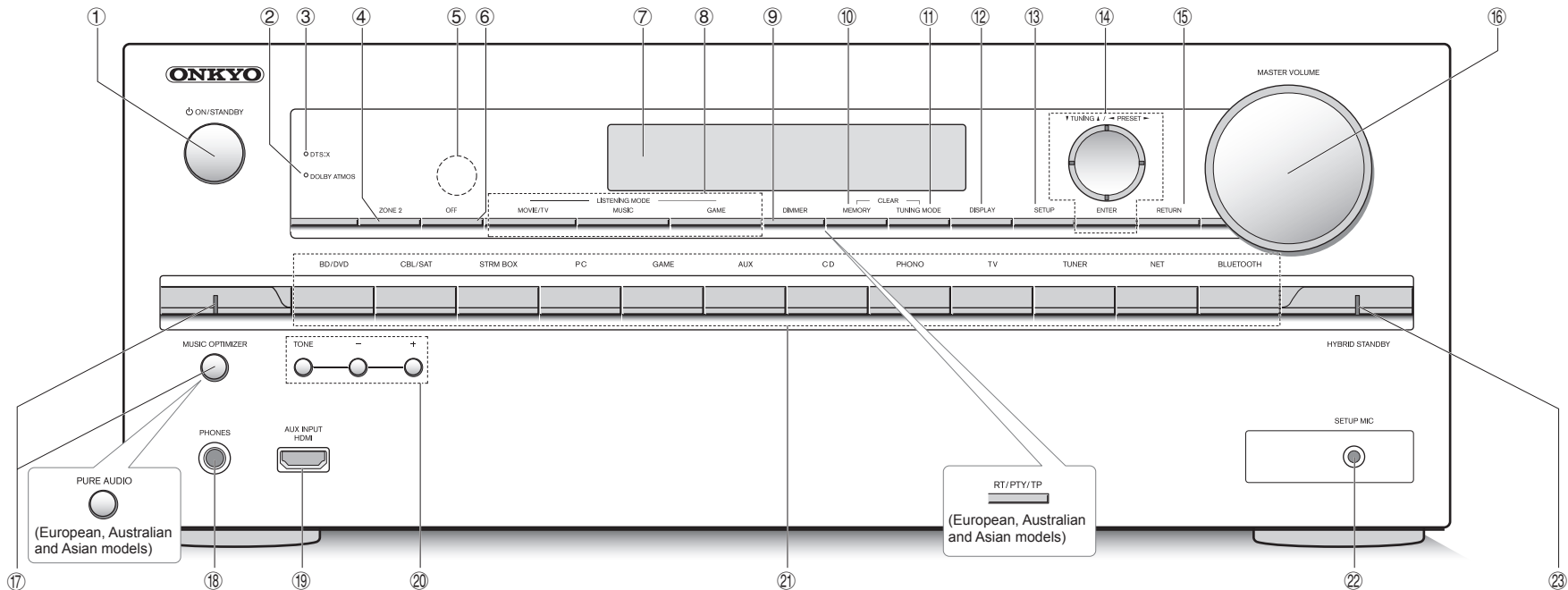

## Front Panel

- ① **ON/STANDBY button:** Turns the unit on or into standby mode.
- ② **DOLBY ATMOS indicator:** Lights when playing Dolby Atmos.
- ③ **DTS:X indicator:** Lights when playing DTS:X.
- ④ **ZONE2 button:** Controls the multi-zone function.
- ⑤ **Remote control sensor:** Receives signals from the remote controller.
- ⑥ **OFF button:** Switches the multi-zone function off.
- ⑦ **Display**
- ⑧ **LISTENING MODE buttons:** Allow you to select the listening mode.
- ⑨ **DIMMER button (North American and Taiwanese models):** Switches the brightness of the display.  
**RT/PTY/TP button (European, Australian and Asian models):** Can be used when receiving the station transmitting text information.
- ⑩ **MEMORY button:** Registers a station.
- ⑪ **TUNING MODE button:** Switches the tuning mode.
- ⑫ **DISPLAY button:** Switches the information on the display.
- ⑬ **SETUP button:** Used when making settings.
- ⑭ **Cursor buttons, TUNING button, PRESET button and ENTER button:** Move the cursor and confirms the selection. When listening to AM/FM broadcasting, tune in to the station with TUNING button and select the registered station with PRESET button.
- ⑮ **RETURN button:** Returns the display to the previous state.
- ⑯ **MASTER VOLUME:** Allows you to adjust the volume.
- ⑰ **MUSIC OPTIMIZER button/indicator (North American and Taiwanese models):** Turns on/off the MUSIC OPTIMIZER function that improves the quality of the compressed audio.  
**PURE AUDIO button/indicator (European, Australian and Asian models):** The display and analog video circuits are turned off to switch the unit to Pure Audio mode and provide purer sound.
- ⑱ **PHONES jack:** Stereo headphones with a standard plug are connected.
- ⑲ **AUX INPUT HDMI jack:** A HD camera or such other device is connected.
- ⑳ **TONE and Tone Level buttons:** Adjust the high tone and low tone.
- ㉑ **Input selector buttons:** Switch the input to be played.
- ㉒ **SETUP MIC jack:** The supplied speaker setup microphone is connected.
- ㉓ **HYBRID STANDBY indicator:** Lights if the unit enters standby mode when the HDMI Standby Through, USB Power Out at Standby, Network Standby or Wakeup from Bluetooth function is enabled.

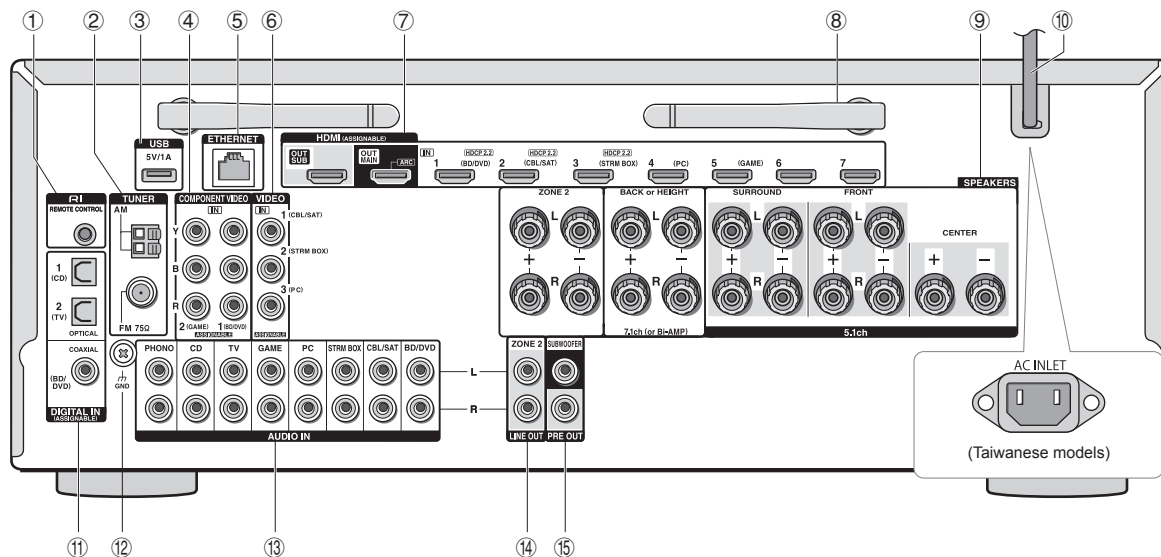

## Rear Panel

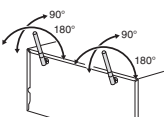
- ① **RI REMOTE CONTROL jack:** An Onkyo product with RI jack can be connected and synchronized with this unit.
- ② **TUNER AM/FM (75Ω) terminal:** The supplied antennas are connected.
- ③ **USB port:** A USB storage device is connected so that music files stored in it can be played. USB devices can be supplied with power when connected with a USB cable.
- ④ **COMPONENT VIDEO IN jack:** Component video input jack
- ⑤ **ETHERNET port:** Used for LAN connection
- ⑥ **COMPOSITE VIDEO IN jacks:** Analog video signals are input.
- ⑦ **HDMI IN/OUT jacks:** Digital video signals and audio signals are transmitted between the unit and the connected devices.
- ⑧ **Wireless antenna:** Used for Wi-Fi connection or when using a Bluetooth-enabled device. Adjust their angles according to the connection status.
 
- ⑨ **SPEAKERS terminals:** Speakers are connected. To use the Multi-zone function, connect the speakers in the separate room to the ZONE2 speaker terminals.
- ⑩ **Power cord (North American, European, Australian and Asian models)**  
**AC INLET (Taiwanese models):** The supplied power cord is connected.
- ⑪ **DIGITAL IN COAXIAL/OPTICAL jacks:** Digital audio signals are input.
- ⑫ **GND terminal:** The ground wire of the turntable is connected.
- ⑬ **COMPOSITE AUDIO IN jacks:** Analog audio signals are input.
- ⑭ **LINE OUT ZONE 2 jack:** Audio output jack connected to the pre-main amplifier for multi-zone playback in a separate room.
- ⑮ **PRE OUT SUBWOOFER jack:** A subwoofer with built-in amplifier is connected.

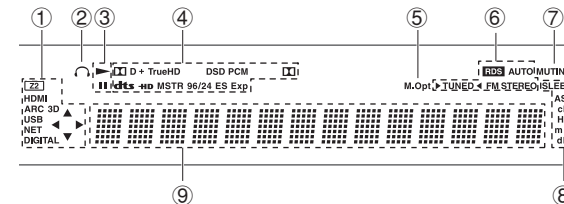

## Display

- ① Lights in the following conditions. "Z2": Zone 2 output is on. / "HDMI": HDMI signals are input and HDMI input selector is selected. / "ARC": Audio signals are input from ARC compatible TV and TV input selector is selected. / "3D": Input signals are 3D. / "USB" (\*): "NET" input is selected and USB storage device is connected. / "NET" (\*): "NET" input is selected and the unit is connected to the network. / "DIGITAL": Digital signals are input and the digital input selector is selected. / Cursor indicators: NET or USB is controlled.  
\* "USB" and "NET" will flash if the connection is not correct.
- ② Stays lit when headphones are connected.
- ③ Lights when NET or USB is controlled.
- ④ Lights according to the type of input digital signals and the listening mode.
- ⑤ Stays lit when Music Optimizer is enabled.
- ⑥ Lights in the following conditions. "AUTO": Tuning mode is auto. / "►TUNED◄": Receiving AM/FM radio. ►◄ flashes while tuning is automatically performed. / "FM STEREO": Receiving FM stereo. / "RDS" (European, Australian and Asian models): Receiving RDS broadcasting.
- ⑦ "MUTING": Flashes when muting is on.
- ⑧ Lights in the following conditions. "SLEEP": Sleep timer has been set. / "ASb" (Auto Standby): Auto Standby is on. / "ch": Channel is being set. / "Hz": Crossover frequencies are being set. / "m/ft": Speaker distances are being set. / "dB": Speaker volume is being set.
- ⑨ Displays various information of the input signals. Pressing DISPLAY displays the type of input digital signals and the listening mode.

# Step 1: Connections

## 1 Connecting speakers

### Speaker layout

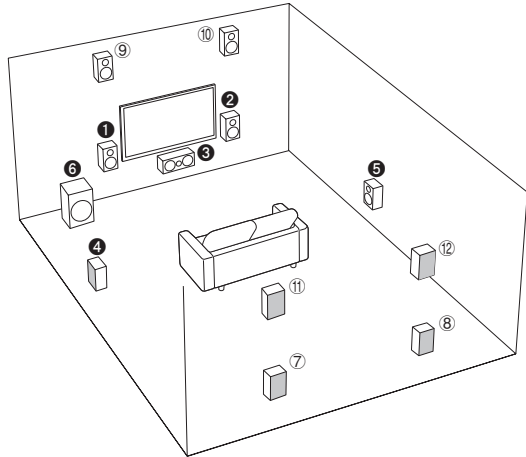

**Important:** The power cord must be connected only after all other connections are completed.

- ① ② Front speakers
  - ③ Center speaker
  - ④ ⑤ Surround speakers
  - ⑥ Subwoofer
  - ⑦ ⑧ Back speakers
  - ⑨ ⑩ Height speakers (Front High)
  - ⑪ ⑫ Height speakers (Rear High)
    - 5.1 ch: ①②③④⑤⑥
    - 7.1 ch: ①②③④⑤⑥+⑦⑧ or ①②③④⑤⑥+⑨⑩ or ①②③④⑤⑥+⑪⑫
- ⑦⑧ speakers, ⑨⑩ speakers and ⑪⑫ speakers share the same speaker terminals. Select either of the groups.

- To enjoy the Dolby Atmos listening mode, height speakers or back speakers need to be installed. There are a variety of height speakers apart from this type. see the next section for details.
- To use the multi-zone function, see "Multi-zone" in "Step 3: Playing Back".

### Characteristics of speaker types

①② output front stereo sound and ③ output center sound such as dialogs and vocals. ④⑤ create back sound field. ⑥ reproduces bass sounds and creates rich sound field.

Connecting ⑦⑧ speakers, ⑨⑩ speakers or ⑪⑫ speakers enables playback in 7.1 ch configuration. ⑦⑧ (back) speakers improve sense of envelopment created by back sound field as well as seamlessness of back sounds, providing more natural sound experiences in the sound field. ⑨⑩ or ⑪⑫ (height) speakers produce surround effects on a height plane. This unit can perform optimal sound field processing for the type of height speakers actually installed and registered in "Initial Setup".

Dolby Surround listening mode. Install Top Front speakers so that they are positioned at a point between directly above the listening position and directly above the front speakers. Install Top Middle speakers so they are directly above the listening position and directly above the back speakers. You can select (a)(b), (c)(d) or (e)(f) on the unit. For connection with the unit, use the SPEAKER BACK or HEIGHT terminals.

- Dolby Laboratories recommends placing the speakers as described in "Installing speakers in ceiling" to obtain the best Dolby Atmos effect.

### Height speaker types

#### Installing speakers in ceiling

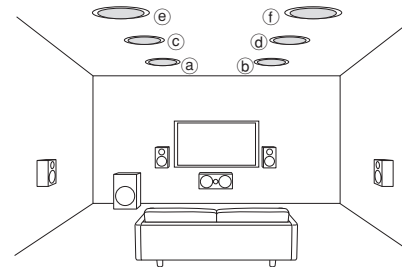

- (a) (b) Top Front
- (c) (d) Top Middle
- (e) (f) Top Rear

Ceiling speakers, etc. are used for maximizing effects in Dolby Atmos or

### Using Dolby Enabled Speakers

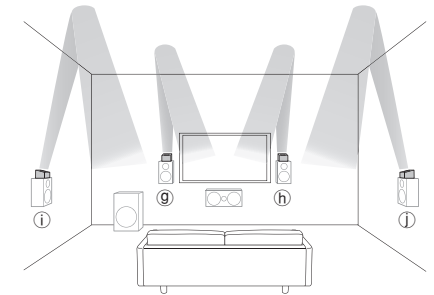

- (g) (h) Dolby Enabled Speakers (Front)
- (i) (j) Dolby Enabled Speakers (Surround)

A Dolby Enabled Speaker is specially designed to be used as a height speaker. There are two types of Dolby Enabled Speakers; one type is designed to be placed on top of other speakers such as front speakers and surround speakers,

and the other type is designed to be integrated with normal speakers. Dolby Enabled Speakers placed with their diaphragms facing toward the ceiling create higher effect in the Dolby Atmos and Dolby Surround listening modes by providing sounds echoing off the ceiling. You can select (9)(h) or (i)(d) on the unit. For connection with the unit, use the SPEAKERS BACK or HEIGHT terminals.

When playing Dolby Atmos, the speakers required depend on how you have setup your back speakers or height speakers. The following shows combinations of speakers for reproducing Dolby Atmos.

Connection pattern	Back or Height	Front		
		Center	Surround	Surround
1	Back	⊗	○	⊗
2	Front High	⊗	○	○
3	Rear High	⊗	○	○
4	Top Front	⊗	○	○
5	Top Middle	⊗	○	○
6	Top Rear	⊗	○	○
7	Dolby Enabled Speaker (Front)	⊗	○	○
8	Dolby Enabled Speaker (Surround)	⊗	○	⊗

⊗: Required, ○: Optional

\* Connection of a subwoofer is optional.

**Important:** (North American and Taiwanese models)  
Connect speakers with 6 Ω to 16 Ω impedance. Using a speaker with less impedance than the supported value may result in failure.

**Important:** (European, Australian and Asian models)  
Connect speakers with 4 Ω to 16 Ω impedance. You have to change the setting if any of the speakers have 4 Ω or more to less than 6 Ω impedance. Using a speaker with less impedance than the setting may result in failure. You can set up by viewing the guidance displayed on the TV screen. Select the item with the cursor buttons of the remote controller and press ENTER to confirm your selection. To return to the previous screen, press RETURN. Press **RECEIVER** and then **SETUP** on the remote controller. Select "2. Speaker" - "Configuration" - "Speaker Impedance" and change the default value from "6ohms" to "4ohms".

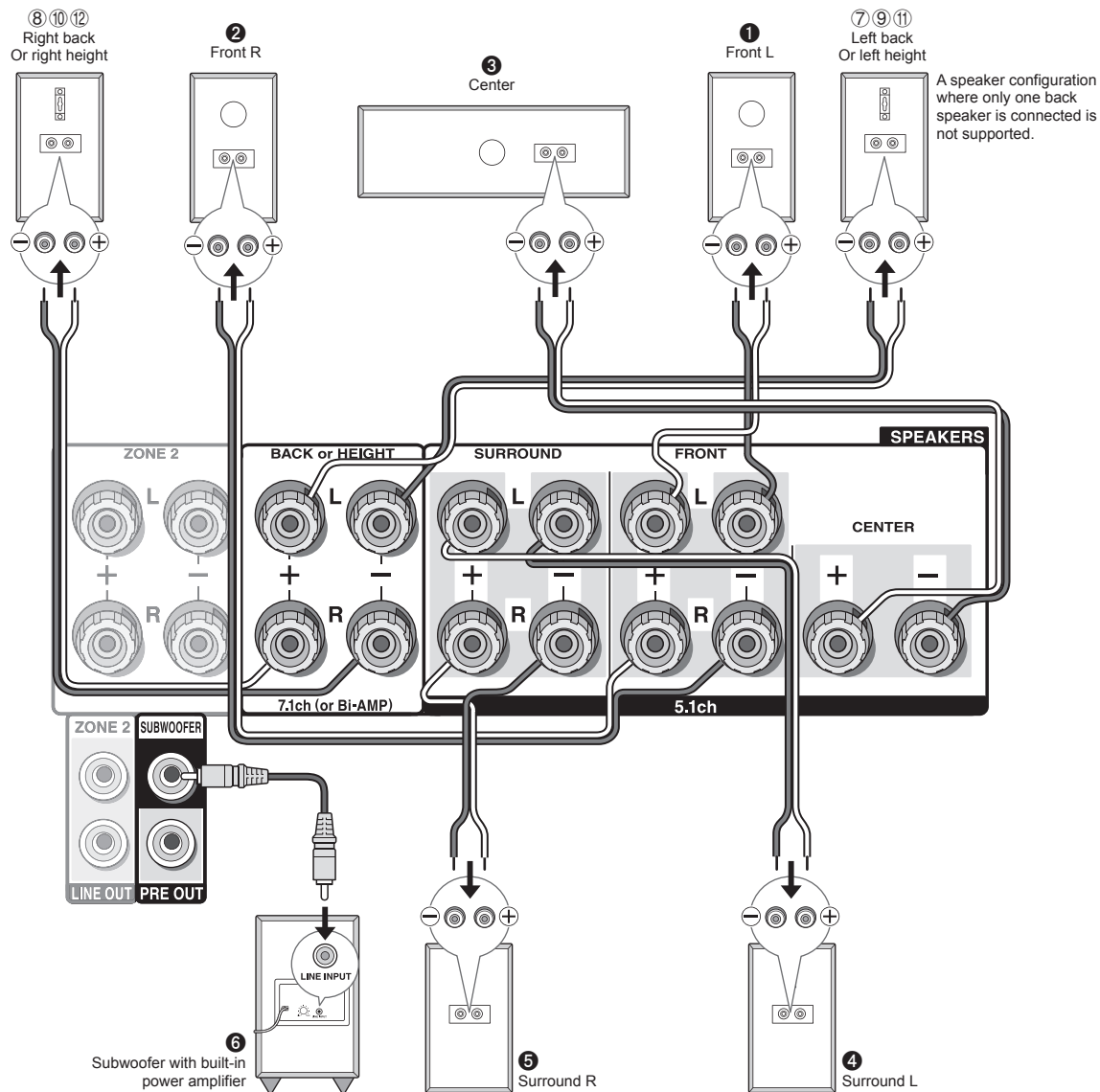

### Instructions on how to connect speakers

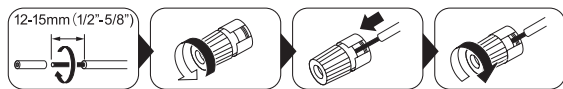

Cut and remove the plastic coating from the end of the speaker cable, twist the core and connect it to the terminal. Be sure to make correct connection between the unit's jacks and speaker's jacks (+ to + and - to -) for each channel. If connection is wrong, a bass sound may become poor due to reverse phase. Up to two subwoofers with built-in power amplifier can be connected to the subwoofer jacks. Set the cut-off filter selection switch of the subwoofer to DIRECT. If the subwoofer does not have a cut-off filter selection switch but has a cut-off frequency adjusting dial, turn it to the maximum frequency. If your subwoofer does not have built-in power amplifier, you can connect a power amplifier between the unit and the subwoofer.

- The speaker setting is 7.1 channels at the time of purchase. You can change it manually or by using automatic speaker setting.
- Short-circuiting the + cable and - cable or contacting the cable core to the rear panel of the unit may cause failure. Also do not connect two or more cables to one speaker terminal or one speaker to several terminals.

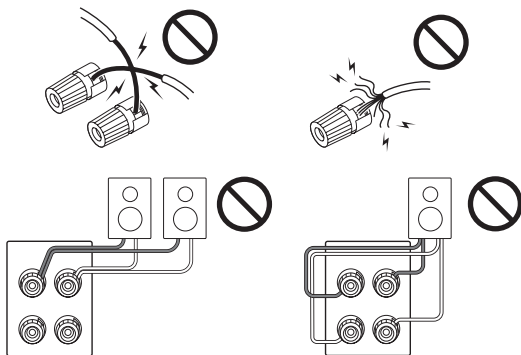
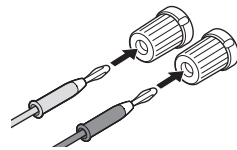

**When using commercially available banana plugs:** tighten the speaker terminals to the end and then insert the banana plugs. Do not insert the core of speaker cable directly into the hole for banana plug of speaker terminal. (North American models)

## 2 Connecting the TV and players

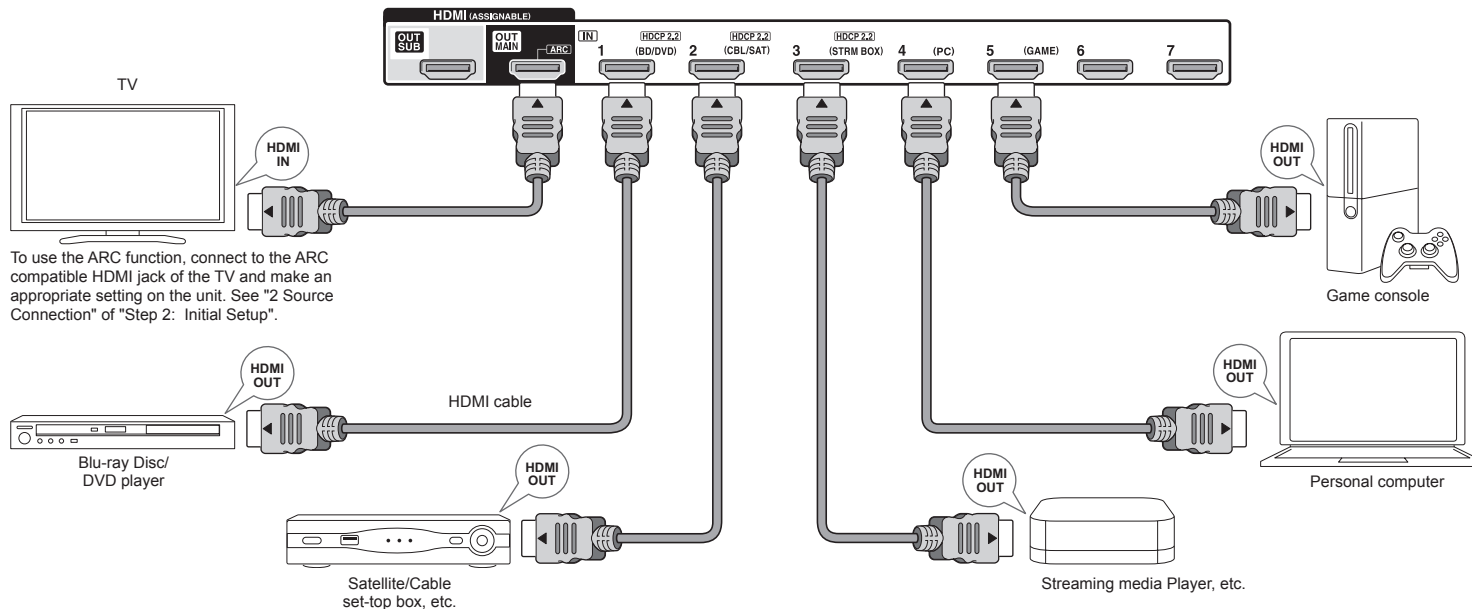

### HDMI cable connection

The unit has many HDMI jacks on its rear panel and each of them corresponds to an input selector button of the same name on the front panel. For example, a Blu-ray Disc player will be connected to the HDMI IN1 jack and the BD/DVD button on the front panel will be used to listen to the playback sound (if the player is CEC compliant, input will be switched automatically when play is started). If you add another Blu-ray Disc player, you can use any other jack than HDMI IN1. It is possible to change assignment of the input jacks and input selector buttons. For how to make settings, see the Advanced Manual.

To connect the TV and the unit, connect the HDMI OUT MAIN jack of the unit and the HDMI IN jack of the TV using a HDMI cable. With this connection, it becomes possible to display the setting screen of the unit on the TV or transmit

video/audio signals from the player to the TV. If your TV supports ARC (Audio Return Channel), it is possible to play the TV sound with the AV receiver's speakers with this connection only. If your TV does not support ARC, you need, in addition to the HDMI OUT MAIN jack connection, a digital optical cable connection between the digital audio out optical jack of the TV and the DIGITAL IN OPTICAL jack of the unit or an analog audio cable connection between the audio output jack of the TV and the AUDIO IN TV jack of the unit.

### ● Audio connection with a TV not supporting ARC

\* Select an appropriate connection for your TV.

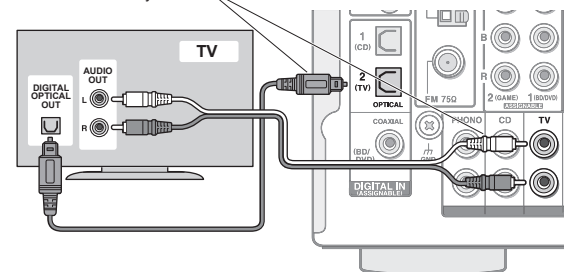

The unit supports the HDMI Standby Through function that allows video and audio signal transmission from players to the TV even if the unit is in standby. You have to



modify the settings to enable the input selection link with CEC (Consumer Electronics Control) compliant device, connection with ARC compatible TV, and HDMI Standby Through function. See "2 Source Connection" of "Step 2: Initial Setup".

- Another TV can be connected to the HDMI OUT SUB jack.
- To enjoy HDCP2.2 protected video, connect the player to one of the HDMI IN1 to IN3 jacks and connect the unit and the TV via HDMI. You will be unable to view images protected by HDCP2.2 if your TV does not have a HDCP2.2 compatible input jack.
- To play 4K or 1080p video, use a high speed HDMI cable or high speed HDMI with Ethernet cable.

### Connecting Components without HDMI

If your AV component does not have HDMI jack, use an available jack of your component for cable connection with this unit.

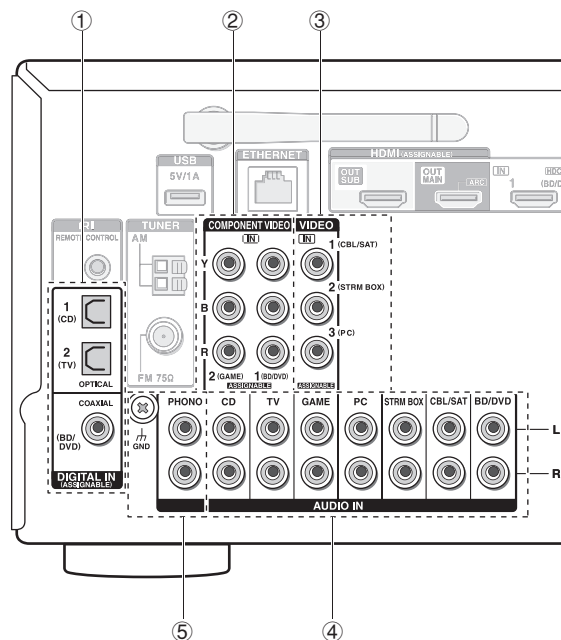

- ① A player with a digital audio out jack can be connected.

 Digital optical cable (OPTICAL)  
 \* As the digital in optical jack of the unit has a cover, push in the cable against the cover as it is turned inside.

 Digital coaxial cable (COAXIAL)

- ② A player with component video output jacks can be connected.

 Component video cable  
 \* Its transmitted video has higher quality than that of composite video cable.

- ③ A player with a composite video output jack can be connected.

 Composite video cable

- ④ A player with analog audio out jacks can be connected. When using jacks ② and ③ for video input, connect to the audio input jacks corresponding to the jacks connected at ② and ③. (For example, when video input connection is to the ② BD/DVD jack, the audio input connection should also be to the ④ BD/DVD jacks.)

- \* It is possible to change assignment of the input jacks and input selector buttons. For how to make settings, see the Advanced Manual.
- \* To enjoy multi-zone playback with a player, connect player to either ① or ④ jacks.

 Analog audio (RCA) cable

- ⑤ Connect a turntable that uses an MM type cartridge and does not have a built-in audio equalizer. If the connected turntable has a built-in audio equalizer, connect it to the ④ CD jack.

- \* If it uses an MC type cartridge, install an audio equalizer compatible with MC type cartridge between the unit and the turntable by connecting it to the ④ CD jack. For details, refer to the turntable's instruction manual.
- \* If the turntable has a ground wire, connect it to the GND terminal of this unit. If connecting the ground wire increases noise, disconnect it.

### Video upconversion function

Video signals input to the composite video input jack or the COMPONENT VIDEO IN jacks will be upconverted to HDMI signals and then output from the HDMI output jack.

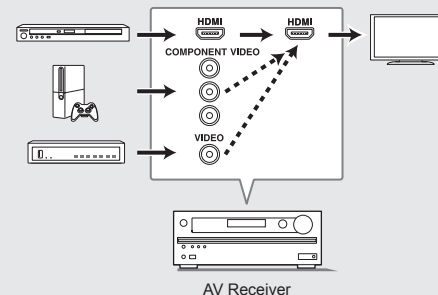

- \* When you upconvert video signals input to the COMPONENT VIDEO IN jacks and output them from the HDMI OUT jack, set the output resolution of the player to 480i or 576i. If the input has 480p/576p or higher resolution, a message prompting you to change the resolution setting will appear. If your player does not support 480i or 576i output, use the composite video jack.
- \* If multiple video signal inputs are put into one input system, the output will be made in the order of HDMI, COMPONENT VIDEO/composite video.

### 3 Other connections

#### AM/FM antenna connections

Connect the antennas to listen to AM/FM broadcast. When listening to the broadcast for the first time, adjust the antenna position and orientation to get the best reception.

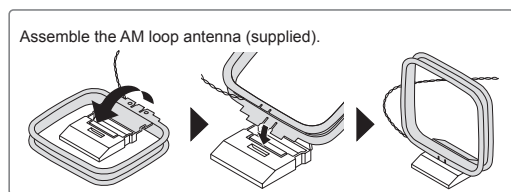
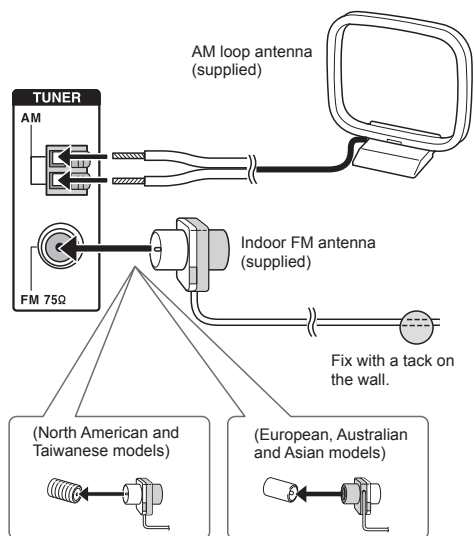

#### Network connection

You can enjoy Internet radio, DLNA and AirPlay by connecting the unit to LAN. The unit can be connected to the router with an Ethernet cable or to the wireless LAN router with Wi-Fi connection. In case of wired connection, connect the Ethernet cable to the Ethernet port. See "4 Network Connection" of "Step 2: Initial Setup" for Wi-Fi settings.

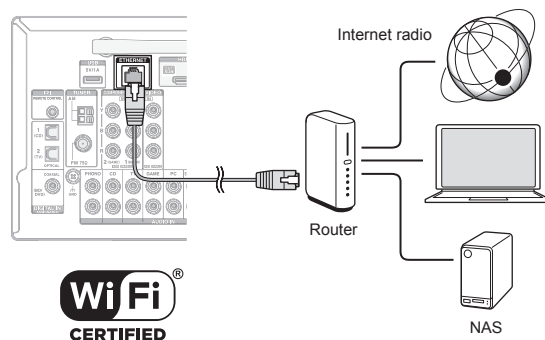

#### Headphones connection

Connect stereo headphones with a standard plug (1/4 inch or  $\varnothing$  6.3 mm) to the PHONES jack on the front panel. Sound from the speakers will be off while you are using the headphones.

- If you selected any other listening mode than Pure Audio (European, Australian and Asian models), Stereo, Mono and Direct, connecting headphones will switch the listening mode to Stereo.

#### Power cord

Taiwanese models include removable power cords. Connect the power cord to AC INLET of the unit and then connect to the outlet. Always disconnect the outlet side first when disconnecting the power cord. When the unit is turned on, a large instantaneous current may flow affecting functionality of the computer and other devices, so it is recommended to use a separate outlet.

# Step 2: Initial Setup

"Initial Setup" automatically starts on the TV when you first turn the unit on.

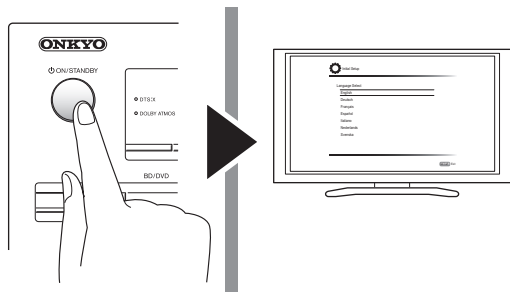

Settings proceed in the following order:

## 1 AccuEQ Room Calibration

- Automatic calibration for optimum speaker settings

## 2 Source Connection

- Checking that each input source is connected correctly
- HDMI link function settings

## 3 Remote Mode Setup

- Settings required to operate other AV Components with the Remote Controller

## 4 Network Connection

- Checking network connections
- Wi-Fi settings

\* **Firmware update notification:** If the unit is connected via LAN and there is firmware update available, the "Firmware Update Available" message will appear. To execute updating, select "Update Now" with the cursor buttons of the remote controller and press ENTER. The unit automatically turns itself into standby mode about 3 minutes after "Completed!" appears on the display, and updating will be complete.

## Before Start

Setup is performed as a series of responses to questions asked by the unit. Select the item with the cursors of the remote controller and press ENTER to confirm your selection. To return to the previous screen, press RETURN.

- You need to use HDMI connection between the unit and TV.
- Switch the input on the TV to that assigned to the unit.

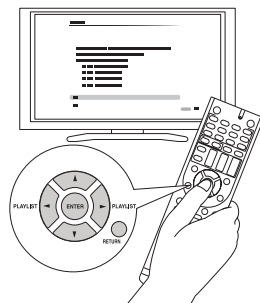

Select the language first. Next, a summary of the initial settings is displayed. Select "Yes" in this screen and press ENTER on the remote controller.

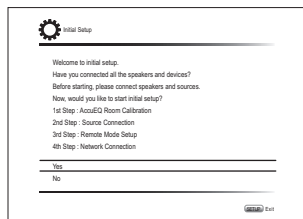

**Re-doing initial setup:** If you terminate the procedure on the way or change the setting made in the initial setup and want to call up the setup wizard again, press **RECEIVER** and then **SETUP** on the remote controller, select "8. Miscellaneous" - "Initial Setup", and press ENTER.

## 1 AccuEQ Room Calibration

The test tone coming from each speaker will be measured to enable setting of the number of speakers, volume level, each speaker's optimum crossover frequencies, and distance from the primary listening position, and also enable correction of distortion caused by the room acoustic environment.

- You cannot return to the previous screen during speaker setup, even if you press RETURN.

### 1. Place the speaker setup microphone.

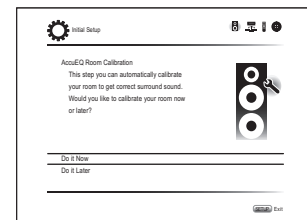

When the screen above is displayed, before starting the procedure, place the supplied speaker setup microphone at the measurement position ★ by referring to the following figure.

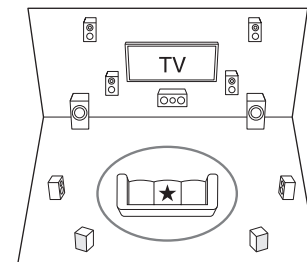

○ : Listening area      ★ : Measurement position with microphone

\* Correct measurement will not be possible if the microphone is held by hand. Measurement is not possible if headphones are being used.

- \* The subwoofer sound may not be detected since it is extremely low frequencies. Set the subwoofer volume to around the half of its maximum volume and make its frequency to the maximum level.
- \* Measurement may be interrupted if there is ambient noise or radio frequency interference. Close the window and turn off the home appliance and fluorescent light.

2. After placing the microphone at the measurement position, select "Do it Now" with the cursors and press ENTER.
3. When "Please plug microphone that came in a box with AV receiver" is displayed, connect the microphone to the SETUP MIC jack of the unit.

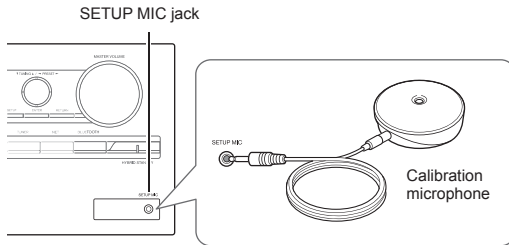

4. Select the settings for the connected speakers, the type of the height speakers, and other appropriate settings.

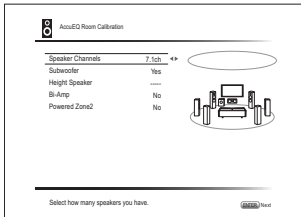

When the screen above is displayed, set the items with the cursor buttons on the remote controller. Refer to the on-screen diagram for "Speaker Channels", which changes each time a different number of channels is selected. When all the items have been set, press ENTER on the remote controller. After that, follow the guidance displayed on the TV screen to operate the unit.

- Refer to the content of an item, which appears on the lower left of the screen when the cursor is on the item.

5. The test tones sound from the connected speakers and automatic speaker setting starts. Measurement will be made 3 times or more for each speaker. It takes several minutes to be completed. Keep the room as quiet as possible during measurement. If any of the speakers do not produce the test tone, check for disconnection.
  - During measurement, each speaker outputs the test tones at a high volume. Be careful of sound leak that may disturb your neighbors, or be careful not to frighten young children.
6. When the measurement is completed, the measurement result is displayed. Press ◀/▶ on the remote controller to check the settings. Press ENTER with "Save" selected. Select "On" in the next screen and press ENTER on the remote controller.
  - You should normally select "On (All Channels)", and to disable just the front speakers, you should select "On (Except Front Left/Right)".
  - If there is an error message, follow the on-screen instruction to remove the error cause.
7. When "Please unplug setup microphone." is displayed, disconnect the microphone.

## 2 Source Connection

You can check the connections on the different inputs and make HDMI link function settings.

1. When the Source Connection start screen is displayed, select "Yes, Continue" with the cursors and press ENTER.

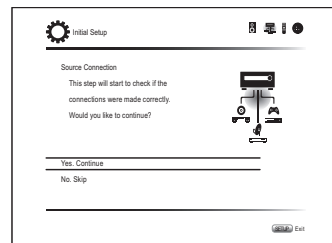

2. Select the desired input to check the connection and

press ENTER.

Start playback of the selected device. If connection is correct, video/audio of the input source selected on the unit will be played.

3. After checking the connection, select "Yes" with the cursors and press ENTER.
  - If you select "No" and press ENTER, the error cause will be displayed. Follow the guidance to remove the error cause and check the connection again.
4. Select "Yes" with the cursors and press ENTER on the remote controller to check the connection of other inputs or select "No, Done Checking" and press ENTER to skip.
  - If you select "Yes", you will return to the screen of step 2.
  - If you select "No, Done Checking", you will proceed to step 5.
5. Set the CEC link function.
  - Select "Yes" to enable the HDMI link function with CEC-compliant equipment, then select "Yes" again in the next screen.

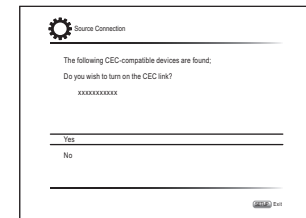

If you select "Yes", the connection with ARC compatible TV and HDMI Standby Through function will be set to "On" and enabled.

### 3 Remote Mode Setup

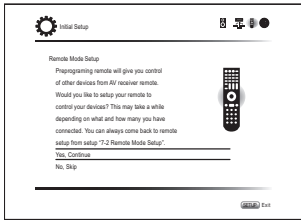

You can enable operation of the other components using the remote controller of the unit. When the Remote Mode Setup start screen is displayed, select "Yes, Continue" with the cursors and press ENTER on the remote controller. Follow the guidance to select the desired REMOTE MODE button and in the keyboard screen, enter the first three characters of the brand name of the device you are going to program and search for the remote control code. The guidance will also explain how to set the remote controller.

### 4 Network Connection



You can check the network connection and make the Wi-Fi setting. When the Network Connection start screen is displayed, select "Yes" with the cursors and press ENTER on the remote controller. If you select "Wired" in the next screen, you can view the LAN cable connection status. To make the Wi-Fi setting, select "Wireless", press ENTER on the remote controller and follow the sections below.

#### Make the following preparations.

Wi-Fi connection requires an access point such as wireless LAN router (\*). Write down the SSID and password (key) of the access point if they are shown in the label of the main body. If the access point has an automatic setting button (may be called differently according to the manufacturer), you can set up without inputting the password. For how to use the automatic setting button of the access point, refer to its instruction manual.

\* The unit supports Wi-Fi connection with 2.4 GHz access point.

#### 1. Select the method of Wi-Fi connection with the cursors and press ENTER.

**Scan Networks:** Use this unit to search for and connect to a wireless LAN router or other access point.

**Use iOS Device (iOS7 or later):** Select this method to let this unit share the Wi-Fi settings with your iOS device and establish a Wi-Fi connection with ease. (The device must be compatible with iOS version 7 or later.)

#### ■ If you selected "Scan Networks"

#### 2. Select the SSID of the access point to be connected with the cursor buttons and press ENTER.

When the SSID of the access point appears on the TV screen, select the desired access point.

- If you changed the initial setting of the access point to skip password entry, step 3 is unnecessary.
- If you changed the initial setting of the access point to hide the SSID, see "When the access point is not displayed".

#### 3. Select and set the authentication method.

The "Enter Password" screen may be displayed automatically if the wireless LAN router does not have an automatic setting button.

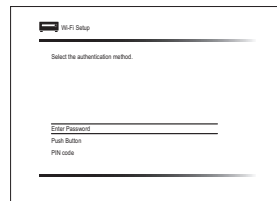

When this screen is displayed, select and set one of the three authentication methods: "Enter Password", "Push

Button" and "PIN code". See below for details of and how to set each method.

**Enter Password:** Enter the password of the access point to establish connection.

- ① Select "Enter Password" with the cursor buttons and press ENTER.
- ② Enter the password (\*) on the keyboard screen, select "OK" with the cursor buttons and press ENTER.
  - \* Select "A/a" and press ENTER to toggle between upper and lower case. Select "-" or "—" and press ENTER to move the cursor to the selected direction. Select  $\square$  and press ENTER to delete the character at the left of the cursor position. To select whether to mask the password with "\*" or display it in plain text, press D on the remote control. Press +10 on the remote controller to switch between upper and lower case. Press CLR to delete all the input characters.
- ③ If the security method of the access point to be connected is WEP, select "Default Key ID", select "OK" and press ENTER.

**Push Button:** Use the automatic setting button of the access point to establish connection.

- ① Select "Push Button" with the cursor buttons and press ENTER.
- ② Hold down the automatic setting button of the access point for the necessary seconds, select "OK" with the cursor buttons and press ENTER.

**PIN code:** Select this method when the automatic setting button of the access point is beyond the reach. Select "PIN code" with the cursor buttons and press ENTER to display the 8-digit PIN code. Register the displayed PIN code to the access point, select "OK" with the cursor buttons and press ENTER. For how to register the PIN code to the access point, refer to its instruction manual.

**When the access point is not displayed**

Select "Other..." with the ► cursor on the remote controller and press ENTER to display the keyboard screen. Input the SSID and password. Make the following settings according to the router setting.

**■ WPA/WPA2 method**

Select "WPA" or "WPA2" in "Security Method", select "OK" and press ENTER.

**■ WEP method**

Select "WEP" in "Security Method" and select "Default Key ID". Then select "OK" and press ENTER.

- If encryption setting has not been made on the wireless LAN router, select "None" in "Security Method", select "OK" and press ENTER.

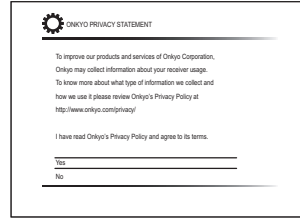
**■ Terminating initial setup**

After finishing the initial setup, keep "Finished" selected and press ENTER on the remote controller. Connection and setting of the unit is now complete.

**Audio output of connected players**

To enjoy digital surround sound including Dolby Digital and DTS, audio output should be set to "Bitstream output" on the connected Blu-ray Disc Player or other device.

Depending on the settings on the Blu-ray Disc Player, there may be cases when Dolby TrueHD, Dolby Atmos, and DTS-HD Master Audio is not output according to the format of the source.

In this case, in the Blu-ray Disc Player settings try setting "BD video supplementary sound" (or secondary sound) to "Off". Change the listening mode after changing the setting to confirm.

**■ If you selected "Use iOS Device (iOS7 or later)"**

2. On the iOS device, go to "Settings"->"Wi-Fi" and turn on the setting, then select this unit in "SETUP NEW AIRPLAY SPEAKER".

3. Tap "Next".

**■ When connection is successful**

"Successfully Connected" is displayed on the screen.

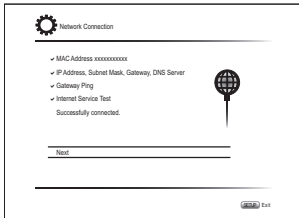

If the screen is not displayed, try doing the setting again. If "Push Button" connection with the wireless LAN router does not work, try "Enter Password".

- A confirmation screen asking you to agree to the privacy policy is displayed after connection. Select "Yes" and press ENTER to indicate agreement.

# Step 3: Playing Back

## 1 Basic Operations

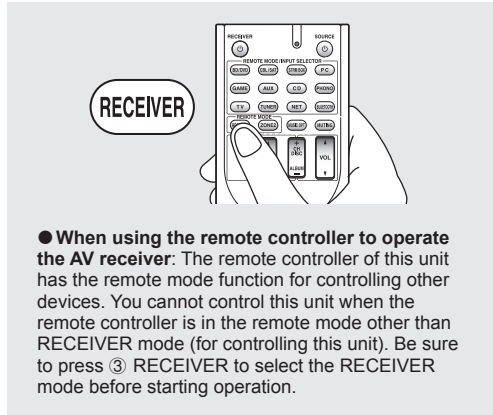

### 1. Turning the power on.

Press ① **RECEIVER** on the remote controller to turn the power on.

- Switch the input on the TV to that assigned to the unit. Use the TV's remote controller.

### 2. Select the input on the unit.

Press the ② **INPUT SELECTOR** button for the player you want to listen to. Press TV to listen to the TV's sound. You can also use the input selector buttons on the main unit.

- Input will automatically be selected if the TV or player is CEC compliant and connected to the unit with HDMI cable.

### 3. Select the desired listening mode.

After pressing ③ **RECEIVER**, press the ⑥ listening mode buttons to switch the mode so that you can enjoy different listening modes.

### 4. Adjust the volume with ⑪ **VOL.**

## Part names and functions of the remote controller

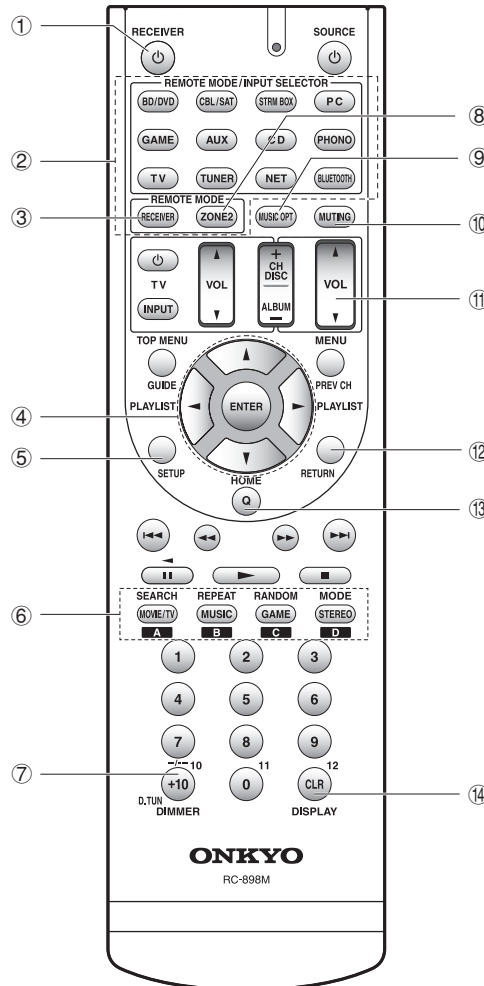

① **RECEIVER** button: Turns the unit on or into standby mode.

② **REMOTE MODE/INPUT SELECTOR** buttons: Switch the input to be played. Furthermore, by registering a particular remote control code to a button, you can switch the remote control mode to operate other equipment by pressing that button.

③ **RECEIVER** button: Switches the remote controller to the mode for operating this unit.

④ **Cursor buttons and ENTER** button: Move the cursor and confirms the selection.

⑤ **SETUP** button: Displays the screen for making various settings for this unit.

⑥ **Listening mode buttons**: Allow you to select the listening mode.

**MOVIE/TV** button: You can select a listening mode suitable for movies and TV programs.

**MUSIC** button: You can select a listening mode suitable for music.

**GAME** button: You can select a listening mode suitable for games.

**STEREO** button: You can select a listening mode for stereo and all channel stereo sources.

- For details on the listening modes, see the Advanced Manual.

⑦ **DIMMER** button: Switches the brightness of the display.

⑧ **ZONE2** button: For use when the unit is connected with a pre-main amplifier or speakers in a separate room and sound is played there.

⑨ **MUSIC OPT** button: Turns on/off the MUSIC OPTIMIZER function that improves the quality of the compressed audio.

⑩ **MUTING** button: Temporarily mutes audio. Press again to cancel muting.

⑪ **VOLUME** buttons: Allow you to adjust the volume. This button also cancels the muting.

⑫ **RETURN** button: Returns the display to the previous state.

⑬ **Q** button: Displays the Quick Setup menu that allows you to quickly access the frequently used setting items including sound quality adjustment.

⑭ **DISPLAY** button: Switches the information on the display.

## 2 Network Functions

You can enjoy sources such as Internet radio by connecting the unit to a network. For details on the operation, see the Advanced Manual.

- The on-screen displays are not displayed when the OSD language is set to Chinese. Operate by confirming the display on the main unit. (European, Australian, Taiwanese and Asian models)

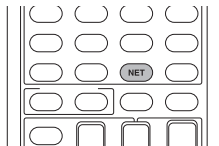

Press NET on the remote controller to display the NET TOP screen on the TV. Select the item with the cursors of the remote controller and press ENTER to confirm your selection.

- \* To return to the previous screen, press RETURN.
- \* Available services may vary depending on your area of residence.

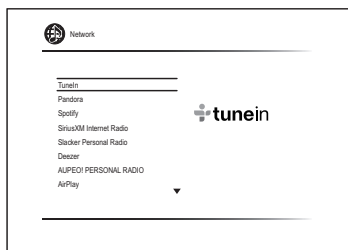

### Internet radio services

The unit comes preset with Internet radio services (\*) such as TuneIn. After selecting the desired service, follow the on-screen instructions, using the cursors to select radio stations and programs, then press ENTER to play.

### DLNA

You can play music files stored in the computer or NAS device connected to the network. Select the server with the cursors, select the desired music file and press ENTER to start playback.

- This unit needs to be connected to the same router as a computer or NAS device.

### Home media

You can play music files in a shared folder on the computer or NAS device connected to the network. Select the server with the cursors, select the desired music file and press ENTER to start playback.

- This unit needs to be connected to the same router as a computer or NAS device.

### USB

Connect the USB storage device to the USB port on the rear of the unit, select the desired folder or music file with the cursors, and press ENTER to confirm and start playback.

## 3 AirPlay®

You can wirelessly enjoy music files stored on an iPhone®, iPod touch®, or iPad®. You can also play back music files on the computer with iTunes.

**Important:** This unit needs to be connected to the network through the same router as the iOS terminal or PC.

### Playing music files from an iPhone, iPod touch, or iPad

Update the OS version on your iOS device to the latest version before connecting it to this unit.

- Press NET on the remote controller.
- Tap the AirPlay icon, select this unit from the list of devices displayed, and click "Done".

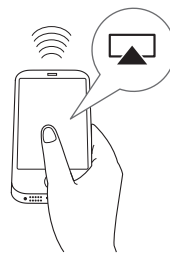

- The AirPlay icon is displayed in the control center if you are using iOS 7 and later. To display the control center,

swipe from the bottom of the screen of the iOS device.

- If the AirPlay icon is not displayed, confirm that this unit and the iOS device are both connected to the router correctly.

### 3. Play music files from an iPhone, iPod touch, or iPad.

#### Playing music files from a computer

- AirPlay is compatible with iTunes 10.2 or later.

- Press NET on the remote controller.
- Turn on your computer and start iTunes.
- Click the AirPlay icon of iTunes and select this unit from the list of devices displayed.
- Play iTunes music files.

- If "6. Hardware"->"Power Management"->"Network Standby" is set to on in the Setup menu, then once AirPlay starts, this unit turns on automatically and the "NET" input source is selected. Even if this setting is "Off", if the unit is already on then the "NET" input source can be selected.
- Due to the characteristics of AirPlay wireless technology, the sound produced on this unit may slightly be behind the sound played on the AirPlay-enabled device.
- Information such as the name of the track is displayed on the unit's display during AirPlay playback.
- There may be some differences in how operations are performed depending on the iOS or iTunes version.
- The on-screen displays are not displayed when the OSD language is set to Chinese. Operate by confirming the display on the main unit. (European, Australian, Taiwanese and Asian models)

**Volume:** The volume of this unit and the AirPlay-enabled device are linked. Take care that the volume does not become too loud when you adjust the volume on the AirPlay-enabled device. You may damage the unit or the speakers. Stop play on the AirPlay-enabled device immediately if the volume becomes too loud at any point.



## 4 Bluetooth®

You can wirelessly enjoy music files stored in a smartphone or other Bluetooth-enabled device. The coverage area is 48 feet (15 meters).

- The Bluetooth-enabled device needs to support the A2DP profile.
- Note that connection is not always guaranteed with all Bluetooth-enabled devices.

### ■ Pairing

Pairing is necessary when connecting the Bluetooth-enabled device for the first time. Before starting the procedure, learn how to enable the Bluetooth setting function and to connect with other devices on the Bluetooth-enabled device.

#### 1. Press **BLUETOOTH** on the remote controller.

The unit begins pairing and "Now Pairing..." is displayed.

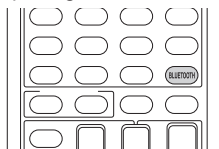

#### 2. While "Now Pairing..." is on the display, complete connection on the Bluetooth-enabled device in the nearby area within about 2 minutes.

If the name of this unit is displayed on the Bluetooth-enabled device's display, select this unit. Pairing will end after a short time.

- If a password is requested, enter "0000".
- You can pair with another Bluetooth-enabled device by pressing and holding the **BLUETOOTH** button until "Now Pairing..." is on the display. This unit can store the data of up to 8 paired devices.

### ■ Playing Bluetooth-enabled devices

If the unit is on and the Bluetooth-enabled device is connected, the input will be automatically switched to **BLUETOOTH**. Play music in this state.

For details on using the remote controller for these operations, see the Advanced Manual.

- It may take about a minute until connection is established when the unit is on since the Bluetooth

function takes some time to start up.

- If the volume setting on the Bluetooth-enabled device is low, the sound will not be output from this unit.
- Due to the characteristics of Bluetooth wireless technology, the sound produced on this unit may slightly be behind the sound played on the Bluetooth-enabled device.
- The on-screen displays are not displayed when the OSD language is set to Chinese. Operate by confirming the display on the main unit. (European, Australian, Taiwanese and Asian models)

## 5 AM/FM Radio

The Basic Manual explains the method using automatic tuning. For manual tuning, see the Advanced Manual.

#### 1. Press **TUNER** on the main unit several times to select either "AM" or "FM".

#### 2. Press **TUNING MODE** on the unit, so that the "AUTO" indicator on the display lights.

#### 3. Press **▼TUNING▲** on the unit.

The automatic tuning to a radio station starts. Searching stops when one is tuned. When tuned into a radio station, the "▶TUNED◀" indicator on the display lights. The "FM STEREO" indicator lights if the radio station is an FM radio station.

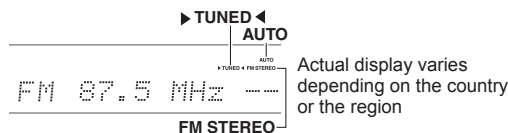

**Registering a radio station:** You can register up to 40 of your favorite AM/FM radio stations.

1. Tune into the AM/FM radio station you want to register.
2. Press **MEMORY** on the unit so that the preset number on the display flashes.
3. Press **◀PRESET▶** on the unit several times to select a number between 1 and 40 while the preset number is flashing (about 8 seconds).
4. Press **MEMORY** again on the main unit to register the station.

When registered, the preset number stops flashing.

To select a preset radio station, press **◀PRESET▶** on the main unit or **CH +/-** on the remote controller.

- To delete a preset station, after selecting the preset number you want to delete with **◀PRESET▶** on the main unit, press **TUNING MODE** while holding down **MEMORY** on the main unit. When the preset number is deleted, it disappears from the display.

### AM/FM frequency step setting

It may be necessary for you to change the frequency step to tune the radio in your area. Change the step with the following procedure. Note that when this setting is changed, all radio presets are deleted.

1. After pressing **RECEIVER** on the remote controller, press **SETUP**.
2. Use the cursor buttons to select "6. Hardware" and press **ENTER**.
3. Select "Tuner" with the cursor and press **ENTER**.
4. Select "AM / FM Frequency Step" (North American and Taiwanese models) or "AM Frequency Step" (European, Australian and Asian models) with the cursor and select the frequency step for your area.  
**(For Taiwanese models only)**  
The setting is "10 kHz / 0.2 MHz" at the time of purchase. Please change it to "9 kHz / 0.05 MHz".

## 6 Multi-zone

You can listen to audio in a room (called Zone 2) other than the one where this unit is located (called the main room).

### ■ Sources you can playback

- External players
- NET
- Bluetooth
- AM/FM Radio

### Important: Connection with external players

To listen to a player in Zone 2, you must connect using an RCA cable, a digital optical cable (OPTICAL), or a digital coaxial cable (COAXIAL). Some players may require audio output setting.

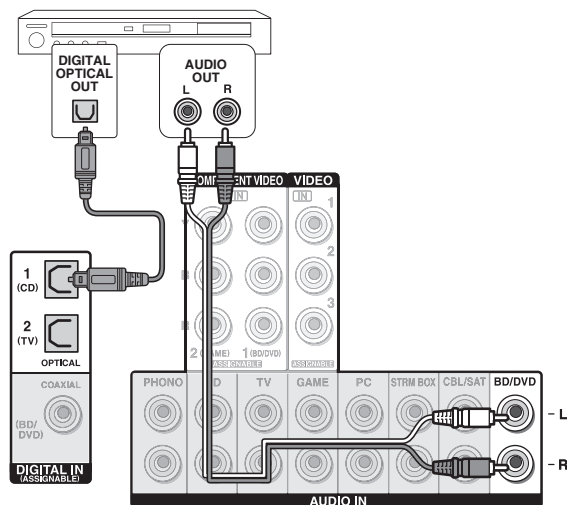

### Making Multi-zone Connection

There are the following two methods of connection:

- Connecting with a pre-main amplifier in a separate room
- Connecting with speakers in a separate room

#### ■ a. Connecting with a pre-main amplifier in a separate room

It is possible to play 2 ch source in a separate room while 7.1 ch source is being played in the main room.

Connect the LINE OUT ZONE2 jacks of the unit and the line-in jacks of the pre-main amplifier in a separate room with an RCA cable.

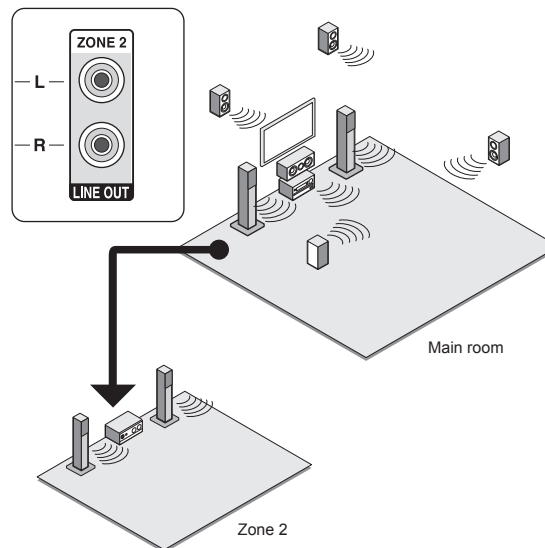

- The volume should be adjusted with the pre-main amplifier used in the separate room.

#### ■ b. Connecting with speakers in a separate room

Connect the speakers in another room to the SPEAKERS ZONE2 jacks of the unit using speaker cables. Note that 5.1 ch will be the maximum (\*) in the main room during Zone 2 playback. No sound will be output from the back speakers and height speakers.

\* In this case, the Dolby Atmos listening mode cannot be selected.

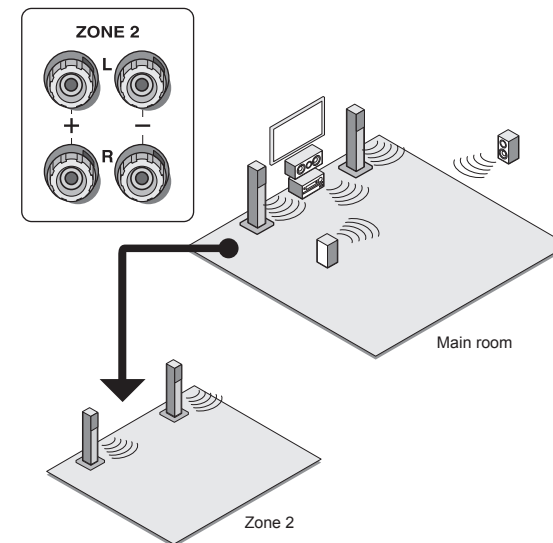

**These settings are required:** After connecting the speakers, press **RECEIVER** and then **SETUP** on the remote controller, select "2. Speaker" - "Configuration" and set "Powered Zone2" to "Yes".

- Adjust the volume on this unit. To adjust the volume, press **ZONE2** on the remote controller and then adjust with **VOL▲/▼**. To control on the main unit, press **ZONE 2** and within 8 seconds, adjust with the **MASTER VOLUME** control. You can mute the sound by pressing **MUTING** on the remote controller.

## Performing Multi-zone Playback

It is possible to perform playback in the main room and a separate room at the same time, for example by playing the Blu-ray Disc player in the main room where the unit is placed while playing Internet radio in a separate room. It is also possible to perform playback only in a separate room.

- With external players, it is possible to play the same source or different sources in the main room and separate room.
- With "NET" and "BLUETOOTH", you cannot select different inputs for the main room and separate room. For example, if "NET" has been selected in the main room and then "BLUETOOTH" is selected as playback source in the separate room, the input in the main room will change to "BLUETOOTH" accordingly.
- When listening to AM/FM broadcasting, you cannot select different stations for the main room and separate room. Therefore broadcasting of the same station will be heard in the both rooms.

## Playing Back

1. Press ZONE2 on the remote controller, point the remote controller at the main unit and press **RECEIVER**.

"Z2" lights on the main unit display and the multi-zone function is enabled. (Zone 2 is now on.)

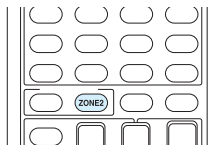

2. Press ZONE2 again on the remote controller and press **INPUT SELECTOR** of the input to be played in a separate room.

- If you turn the unit to standby during multi-zone playback, the Z2 indicator is dimmed and the playback mode is switched to playback in a separate room only. Performing steps 1 and 2 while the unit is in standby also switches the playback mode to playback in a separate room only. To play the same source in the main room and separate room, hold down ZONE2 for approximately 3 seconds.

**To control on the main unit:** press ZONE2 and within 8 seconds, press the input selector button of the source to be

played in the other room. (To play the same source in the main room and separate room, press ZONE2 twice.)

## To turn off the function

After pressing ZONE2 on the remote controller, press **RECEIVER**. Alternatively press OFF on the main unit.

- If ZONE 2 is on, power consumption during standby becomes larger than normal.
- If ZONE 2 is turned on when the listening mode of the main room is Pure Audio, it will automatically switch to the Direct listening mode. (European, Australian and Asian models)
- While ZONE 2 is on, the RI linked system function (interlink between Onkyo components) is disabled.
- Pressing INPUT SELECTOR on the remote controller while you are using the remote controller for Zone 2 will switch the controlled target to the main room. To control Zone 2 again, press the ZONE2 button to enter the Zone control mode.

## 7 Quick Setup Menu

You can perform common settings on the TV screen while playing.

1. Press **Q** on the remote controller.

The Quick Setup menu is displayed on the connected TV's screen.



2. Select the item with the cursors of the remote controller and press **ENTER** to confirm your selection.
  - To return to the previous screen, press RETURN.
3. Select the setting with the cursors buttons of the remote controller.

■ **Listening Mode:** Select the listening mode from the categories of "MOVIE/TV", "MUSIC" and "GAME". After selecting the Listening Mode, press ENTER button to confirm.

- It cannot be set when audio is played from the TV's speakers.

■ **Audio:** You can perform various audio settings including audio quality and speaker level adjustment.

- You cannot select this item when audio is output from the TV's speakers.

**Bass, Treble:** Adjust volume of the front speaker.

- It cannot be set if the listening mode is Pure Audio (European, Australian and Asian models) or Direct.

**Phase Matching Bass:** Suppress phase shift in the midrange to enhance bass sound. Thus smooth and powerful bass sound can be obtained.

- It cannot be set if the listening mode is Pure Audio (European, Australian and Asian models) or Direct.

**Center Level, Subwoofer Level:** Adjust the speaker level while listening to the sound. The adjustment you made will be reset to the previous status when you turn the unit to standby mode.

- Changes may not be possible depending on the settings in speakers.
- This setting is not possible during MUTING or when using headphones.

**A/V Sync:** If the video is behind the audio, you can delay the audio to offset the gap. Different settings can be set for each input selector.

- It cannot be set if the listening mode is Pure Audio (European, Australian and Asian models) or Direct.

**AccuEQ Room Calibration:** Enable or disable the settings made by automatic speaker setting. To enable them, you should normally select "On (All Ch)", and to disable just the front speakers, you should select "On (ex. L/R)". The setting can be separately set to each input selector.

- This setting cannot be selected if the automatic speaker setting has not been performed.
- It cannot be set if headphones are connected or the listening mode is Pure Audio (European, Australian and Asian models) or Direct.

**Equalizer:** Assign the equalizer settings adjusted in "Setup"->"2. Speaker"->"Equalizer Settings" to "Preset1" to "Preset3". The same sound field setting is applied to all

ranges when set to "Off".

- It cannot be set if the listening mode is Pure Audio (European, Australian and Asian models) or Direct.

**Music Optimizer:** Improve the quality of the compressed audio. Playback sound of lossy compressed files such as MP3 will be improved. The setting can be separately set to each input selector.

- The setting is effective in the signals of 48 kHz or less. The setting is not effective in the bitstream signals.
- It cannot be set if the listening mode is Pure Audio (European, Australian and Asian models) or Direct.

**Late Night:** Make small sounds to be easily heard. It is useful when you need to reduce the volume while watching a movie late night. You can enjoy the effect only with Dolby Digital, Dolby Digital Plus, Dolby TrueHD, and DTS sources.

- Turning the unit to standby mode will set the setting to "Off". In case of Dolby TrueHD, the setting will be set to "Auto".
- The setting cannot be used in the following cases.
  - If "Loudness Management" is set to "Off" when playing Dolby Digital Plus or Dolby TrueHD.
  - When the input signal is DTS and "Dialog Control" is other than 0 dB.

**Cinema Filter:** Adjust the soundtrack that was processed to enhance its treble, in order to make it suitable for home theater.

- This function can be used in the following listening modes: Dolby Digital, Dolby Digital Plus, Dolby TrueHD, Multichannel, DTS, DTS-ES, DTS 96/24, DTS-HD High Resolution Audio, DTS-HD Master Audio, DTS Express, DSD.

**Center Spread:** Adjust the width of the sound field of the front channel when playing in the Dolby Surround listening mode.

To spread the width of the sound field to the left and right, set to "On". To concentrate sound in the center, set to "Off".

- This setting may be "Off" depending on the settings in speakers.

**Dialog Control:** You can increase the dialog portion of the audio in 1 dB steps up to 6 dB so that you can make dialog easier to hear over background noise.

- This setting is unavailable for content other than DTS:X.
- This setting may not be available for selection with some content.

■ **HDMI:** Select the HDMI OUT jack to be used for output.

■ **Information:**

**Audio:** Displays the audio input source, format, number of channels, sampling frequency, listening mode, and number of output channels.

**Video:** Displays information such as the video input source, resolution, color space, color depth, 3D information, Aspect and output.

**Tuner:** Displays information such as the band, frequency, and preset number. This is displayed only when "TUNER" is selected as the input source.

## 8 Other useful functions

### To adjust the sound quality

It is possible to enhance or moderate the bass and treble of front speakers. Press TONE on the main unit several times to select the desired setting from "Bass", "Treble" and "Phase Matching Bass", and adjust with +/-.

- It cannot be set if the listening mode is Pure Audio (European, Australian and Asian models) or Direct.
- "Bass":** Allows you to enhance or moderate the bass.  
**"Treble":** Allows you to enhance or moderate the treble.  
**"Phase Matching Bass":** Allows you to keep the clear midrange and effectively enhance the bass.

### Checking the Input Format

Press DISPLAY on the remote controller several times to switch the display of the main unit in order of:

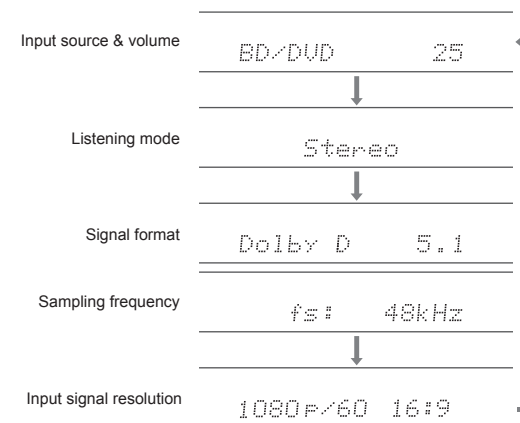

- If "Dolby D 5.1" is displayed in Signal format, the Dolby Digital 5.1 ch signals are being input. When listening to AM/FM radio, the band, frequency and preset number are displayed.

### Playing Audio and Video from Separate Sources

It is possible to play audio and video from different sources. For example, you can play audio from the CD player and video from the BD/DVD player. In this case, press BD/DVD and then CD. Then start playback on the BD/DVD player and CD player. This function is effective when an input with audio only has been selected (CD, NET, BLUETOOTH, TUNER or PHONO in the initial setting).(\*)

\* When NET or BLUETOOTH is selected, press MODE on the remote controller after pressing NET or BLUETOOTH on the remote controller.

## Troubleshooting

### Before starting the procedure

Problems may be solved by simply turning the power on/off or disconnecting/connecting the power cord, which is easier than working on the connection, setting and operating procedure. Try the simple measures on both the unit and the connected device. If the problem is that the video or audio is not output or the HDMI linked operation does not work, disconnecting/connecting the HDMI cable may solve it. When reconnecting, be careful not to wind the HDMI cable since if wound the HDMI cable may not fit well. After reconnecting, turn off and on the unit and the connected device.

### The AV receiver turns off unexpectedly.

- The AV receiver will automatically enter standby mode when Auto Standby or Sleep Timer is set and launched.
- The protection circuit may have been activated. If this is the case, when you turn the unit on again, "AMP Diag Mode" will appear on the main unit's display. The unit will then enter a mode that detects abnormal conditions. If no problems are detected, "AMP Diag Mode" will disappear and the unit will return to a normal state. If "CHECK SP WIRE" appears on the display, the speaker cables may be short-circuited. Turn the unit off, and check to see if the cable core of any of the speaker cables is in contact with that of another speaker cable or with the rear panel. After that, turn the unit on again. If "NG" appears, unplug the power cord immediately and contact your Onkyo dealer.

### There's no sound, or it's very quiet.

- A wrong input selector button has been selected. Select a correct input for the player. Also check that muting is not on.
- Not all listening modes use all speakers.

### There's no picture.

- A wrong input selector button has been selected.
- Video from the analog input is not displayed if the listening mode is Pure Audio. (European, Australian and Asian models)
- To display video from the connected player on the TV screen while the unit is in standby, you need to enable HDMI Standby Through function.
- When the TV image is blurry or unclear, power cord or connection cables of the unit may have interfered. In that case,

keep distance between TV antenna cable and cables of the unit.

- If you connect a player supporting HDCP2.2, be sure to connect it to one of the HDMI IN1 to IN3 jacks of the unit.

### Video and audio are out of synch.

- Video may be delayed relative to audio depending on the settings and connections with your TV. Adjust in "Step 3: Playing Back", "7 Quick Setup Menu", "A/V Sync".

### Cannot play digital surround.

- To enjoy digital surround sound including Dolby Digital and DTS, audio output should be set to "Bitstream output" on the connected Blu-ray Disc Player or other device.

### Cannot output audio such as Dolby Atmos according to the format of the source.

- If you cannot output audio according to the format of the source (Dolby TrueHD, Dolby Atmos, DTS-HD Master Audio, etc.), in the Blu-ray Disc Player settings try setting "BD video supplementary sound" (or secondary sound) to "Off". Change the listening mode for each source after changing the setting to confirm.

### HDMI control does not function correctly.

- Set the CEC link function of the unit to on. It is also necessary to make the HDMI linked system setting on the TV. See the TV's instruction manual for details.

### Cannot access to network.

- Try plugging/unplugging the unit or the wireless LAN router or check their power-on status. This will work well in many cases.
- If the desired wireless LAN router is not in the access point list, it may be set to hide SSID or the ANY connection may be off. Change the setting and try again.

## Resetting the unit

Resetting the unit to the status at the time of shipment may solve the problem. If the measures above do not solve the problem, reset the unit with the following procedure. If you reset the unit status, your preferences will be reset to the defaults. Note them down before starting reset.

### How to reset:

1. While holding down CBL/SAT on the main unit (note that step 2 must be performed with this button pressed down)
2. Press **ON/STANDBY** on the main unit ("Clear" appears on the display and the unit returns to standby).

- Do not unplug the power cord until "Clear" disappears from the display.

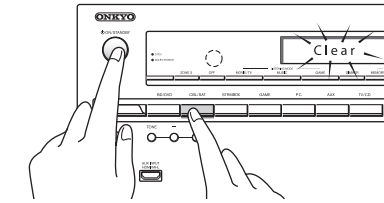

2. Press **ON/STANDBY**.
1. While holding down CBL/SAT,

### How to reset the remote controller:

1. While holding down RECEIVER on the remote controller, press Q until the remote indicator stays lit (about 3 seconds).
2. Within 30 seconds, press RECEIVER again.

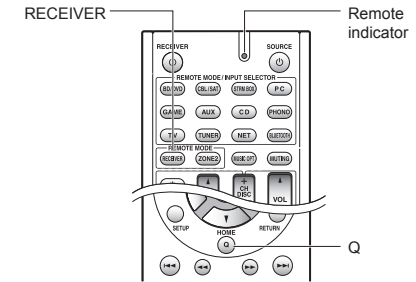

## Specifications

### Amplifier Section

#### Rated Output Power (North American)

With 8 ohm loads, both channels driven, from 20-20,000 Hz; rated 100 watts per channel minimum RMS power, with no more than 0.08% total harmonic distortion from 250 milliwatts to rated output.

Surround Mode Output Power (\*)  
(6 ohms, 1 kHz THD 0.9%) 170 W per channel

\* Reference output for each speakers.

Depending on the source and the listening mode settings, there may be no sound output.

#### Rated Output Power (Others)

7 ch x 160 W at 6 ohms, 1 kHz, 1 ch driven of 1% (IEC)

#### Maximum Effective Output Power

7 ch x 175 W at 6 ohms, 1 kHz, 1 ch driven (JEITA) (Asian)

#### Dynamic Power (\*)

\* IEC60268-Short-term maximum output power

240 W (3 Ω, Front)

210 W (4 Ω, Front)

120 W (8 Ω, Front)

#### THD+N (Total Harmonic Distortion+Noise)

0.08% (20 Hz - 20 kHz, half power)

#### Input Sensitivity and Impedance

200 mV/47 kΩ (LINE, 1 kHz 100 W/8 Ω)

3.5 mV/47 kΩ (PHONO MM)

#### Rated RCA Output Level and Impedance

100 mV/2.3 kΩ (ZONE2 LINE OUT)

1 V/470 Ω (SUBWOOFER PRE OUT)

#### Phono Overload

70 mV (MM 1 kHz 0.5% Direct)

#### Frequency Response

10 Hz - 100 kHz/+1 dB, -3 dB (Direct mode)

#### Tone Control Characteristics

±10 dB, 20 Hz (BASS)

±10 dB, 20 kHz (TREBLE)

#### Signal to Noise Ratio

100 dB (LINE, IHF-A)

80 dB (PHONO MM, IHF-A)

#### Speaker Impedance

6 Ω - 16 Ω (North American and Taiwanese)

4 Ω - 16 Ω/6 Ω - 16 Ω (Others)

### Video Section

#### Signal level

1.0 Vp-p/75 Ω (Component Y)

0.7 Vp-p/75 Ω (Component Pb/Cb, Pr/Cr)

1.0 Vp-p/75 Ω (Composite)

#### Maximum resolution supported by component video

480i/576i

### Tuner Section

#### FM Tuning Frequency Range

87.5 MHz - 107.9 MHz

(North American and Taiwanese)

87.5 MHz - 108.0 MHz, RDS (Others)

#### AM Tuning Frequency Range

522/530 kHz - 1611/1710 kHz

#### Preset Channel

40

### Network Section

#### Ethernet LAN

10BASE-T/100BASE-TX

#### Wireless LAN

IEEE 802.11 b/g/n standard

(Wi-Fi® standard)

2.4 GHz band:

1 - 11 ch (North American)

10 - 11 ch (Spain)

10 - 13 ch (France)

1 - 13 ch (Others)

(Wi-Fi® standard)

### Bluetooth Section

#### Communication system

Bluetooth Specification version 2.1 +EDR (Enhanced Data Rate)

#### Maximum communication range

Line of sight approx. 15 m (\*)

#### Frequency band

2.4 GHz band

#### Modulation method

FHSS (Freq Hopping Spread Spectrum)

#### Compatible Bluetooth profiles

A2DP 1.2 (Advanced Audio Distribution Profile)

AVRCP 1.3 (Audio Video Remote Control Profile)

#### Supported Codecs

SBC

#### Transmission range (A2DP)

20 Hz - 20,000 Hz (Sampling frequency 44.1 kHz)

\* The actual range will vary depending on factors such as obstacles between devices, magnetic fields around a microwave oven, static electricity, cordless phone, reception sensitivity, antenna's performance, operating system, software application, etc.

### General

#### Power Supply

AC 120 V, 60 Hz (North American and Taiwanese)

AC 220 - 240 V, 50/60 Hz (Others)

#### Power Consumption

6.4 A (North American and Taiwanese)

630 W (Others)

0.1 W (Stand-by, North American and Taiwanese)

0.15 W (Stand-by, Others)

2.6 W (Network Standby)

70 W (No-sound)

#### Dimensions (W x H x D)

435 mm x 173.5 mm x 329 mm

17-1/8" x 6-13/16" x 12-15/16"

#### Weight

9.4 kg (20.7 lbs.) (North American and Taiwanese)

9.8 kg (21.6 lbs.) (Others)

### • HDMI

#### Input

IN1 (BD/DVD, HDCP2.2), IN2 (CBL/SAT, HDCP2.2), IN3 (STRM BOX, HDCP2.2), IN4 (PC), IN5 (GAME), IN6, IN7, AUX INPUT HDMI (front)

#### Output

OUT MAIN (ARC), OUT SUB

#### Video Resolution

4K 60 Hz (RGB/YCbCr4:4:4/YCbCr4:2:2, 24 bit)

#### Audio Format

Dolby Atmos, Dolby TrueHD, Dolby Digital Plus, Dolby Digital, DTS:X, DTS-HD Master Audio, DTS-HD High Resolution Audio, DTS 96/24, DTS-ES, DTS, DTS Express, DSD, Multichannel PCM (up to 8ch)

#### Supported

3D, Audio Return Channel, Deep Color, x.v.Color™, LipSync, CEC, 4K, Extended Colorimetry (sYCC601, Adobe RGB, Adobe YCC601), Content Type, 3D Dual View, 21:9 Aspect Ratio Video Format

### • Video Inputs

#### Component

IN1 (BD/DVD), IN2 (GAME)

#### Composite

IN1 (CBL/SAT), IN2 (STRM BOX), IN3 (PC)

### • Audio Inputs

#### Digital

OPTICAL 1 (CD), 2 (TV)

COAXIAL (BD/DVD)

#### Analog

BD/DVD, CBL/SAT, STRM BOX, PC, GAME, TV, CD, PHONO

### • Audio Outputs

#### Analog

ZONE2 LINE OUT

2 SUBWOOFER PRE OUT

#### Speaker Outputs

FRONT L/R, CENTER, SURROUND L/R, BACK or HEIGHT L/R, ZONE2

L/R

#### Phones

PHONES (Front, ø 6.3)

### • Others

Setup Mic 1 (Front)

RI REMOTE CONTROL 1

USB 1 (1.1, 5 V/1 A)

Ethernet 1

#### Supports multi-language on-screen display

(North American) English, German, French, Spanish, Italian, Dutch,

Swedish

(Taiwanese) English, German, French, Spanish, Italian, Dutch, Swedish,

Chinese (\*)

(Others) English, German, French, Spanish, Italian, Dutch, Swedish,

Russian, Chinese (\*)

\* OSD is not displayed when the input selector is "NET" or "BLUETOOTH". Use the display on the main unit when operating the unit.

Specifications and features are subject to change without notice.

## Table of image resolutions

Refer to the following table for information about the image formats and resolutions output by this unit in response to input signals

Input	Output	HDMI						
		4K	1080p/24	1080p	1080i	720p	480p/576p	480i/576i
HDMI	4K	✓						
	1080p/24		✓					
	1080p			✓				
	1080i				✓			
	720p					✓		
	480p/576p						✓	
	480i/576i							✓
	Component	1080p						
	1080i							
	720p							
	480p/576p							
	480i/576i						✓	
Composite	480i/576i						✓	

## Resolutions supported by HDMI

Input support	Content protection technology	Display resolution	Frame rate	Color space	Color Depth	Remarks			
HDMI input IN1 to IN3	HDCP1.4 HDCP2.2	720×480i	60 Hz	RGB/YCbCr4:4:4/ YCbCr4:2:2	8/10/12/16 bit	*			
		720×576i	50 Hz						
		720×480p	60 Hz						
		720×576p	50 Hz						
		1920×1080p	50/60 Hz						
		1280×720p	24/25/30/50/60 Hz						
		1680×720p	24/25/30/50/60 Hz						
		1920×1080p	24/25/30/50/60 Hz						
		2560×1080p	24/25/30 Hz						
			50/60 Hz						
		4K (3840×2160p)	24/25/30 Hz				RGB/YCbCr4:4:4/ YCbCr4:2:2	8/10/12/16 bit	*
			50/60 Hz				RGB/YCbCr4:4:4	8 bit	
							YCbCr4:2:2	12 bit	
							YCbCr4:2:0	8/10/12/16 bit	
		4K SMPTE (4096×2160p)	24/25/30 Hz				RGB/YCbCr4:4:4/ YCbCr4:2:2	8/10/12/16 bit	*
			50/60 Hz				RGB/YCbCr4:4:4	8 bit	
							YCbCr4:2:2	12 bit	
							YCbCr4:2:0	8/10/12/16 bit	
HDMI input IN4 to IN7 Front	HDCP1.4	720×480i	60 Hz	RGB/YCbCr4:4:4/ YCbCr4:2:2	8/10/12/16 bit	*			
		720×576i	50 Hz						
		720×480p	60 Hz						
		720×576p	50 Hz						
		1920×1080i	50/60 Hz						
		1280×720p	24/25/30/50/60 Hz						
		1680×720p	24/25/30/50/60 Hz						
		1920×1080p	24/25/30/50/60 Hz						
		2560×1080p	24/25/30 Hz						
			50/60 Hz						
		4K (3840×2160p)	24/25/30 Hz				RGB/YCbCr4:4:4	8 bit	
			50/60 Hz				YCbCr4:2:2	12 bit	
							YCbCr4:2:0	8 bit	
							YCbCr4:2:0	8 bit	
		4K SMPTE (4096×2160p)	24/25/30 Hz				RGB/YCbCr4:4:4	8 bit	
			50/60 Hz				YCbCr4:2:2	12 bit	
							YCbCr4:2:2	12 bit	
							YCbCr4:2:0	8 bit	

\* With YCbCr4:2:2, Color Depth supported is 12 bit only.

## Precautions

### For European Models

#### Declaration of Conformity

We declare, under our sole responsibility, that this product complies with the standards:

- Safety
- Limits and methods of measurement of radio disturbance characteristics
- Limits for harmonic current emissions
- Limitation of voltage changes, voltage fluctuations and flicker
- RoHS Directive, 2011/65/EU



- Hereby, Onkyo Corporation, declares that this TX-NR646 is in compliance with the essential requirements and other relevant provisions of Directive 1999/5/EC.
- С настоящето, Onkyo Corporation, декларира, че TX-NR646 е в съответствие със съществените изисквания и другите приложими разпоредби на Директива 1999/5/EC.
- Onkyo Corporation tímto prohlašuje, že TX-NR646 splňuje základní požadavky a všechna příslušná ustanovení Směrnice 1999/5/ES.
- Undertegnede Onkyo Corporation erklærer herved, at følgende udstyr TX-NR646 overholder de væsentlige krav og øvrige relevante krav i direktiv 1999/5/EF.
- Hiermit erklärt Onkyo Corporation, dass sich das Gerät TX-NR646 in Übereinstimmung mit den grundlegenden Anforderungen und den übrigen einschlägigen Bestimmungen der Richtlinie 1999/5/EG befindet.
- Käesolevaga kinnitab Onkyo Corporation seadme TX-NR646 vastavust direktiivi 1999/5/EÜ põhinõuetele ja nimetatud direktiivist tulenevatele teistele asjakohastele sätetele.
- ΜΕ ΤΗΝ ΠΑΡΟΥΣΑ Ο ΚΑΤΑΣΚΕΥΑΣΤΗΣ Onkyo Corporation ΔΗΛΩΝΕΙ ΟΤΙ ΤΑ ΧΡΗΜΑΤΑ ΣΥΜΜΟΡΦΩΝΕΤΑΙ ΠΡΟΣ ΤΙΣ ΟΥΣΙΩΔΕΙΣ ΑΠΑΙΤΗΣΕΙΣ ΚΑΙ ΤΙΣ ΛΟΙΠΕΣ ΣΧΕΤΙΚΕΣ ΔΙΑΤΑΞΕΙΣ ΤΗΣ ΟΔΗΓΙΑΣ 1999/5/ΕΚ
- Por la presente, Onkyo Corporation, declara que este TX-NR646 cumple con los requisitos esenciales y otras exigencias relevantes de la Directiva 1999/5/EC.
- Par la présente, Onkyo Corporation déclare que l'appareil TX-NR646 est conforme aux exigences essentielles et aux autres dispositions pertinentes de la directive 1999/5/CE.
- Con la presente Onkyo Corporation dichiara che questo TX-NR646 è conforme ai requisiti essenziali ed alle altre disposizioni pertinenti stabilite dalla direttiva 1999/5/CE.
- Ar šo Onkyo Corporation deklarē, ka TX-NR646 atbilst Direktīvas 1999/5/EK būtiskajām prasībām un citiem ar to saistītajiem noteikumiem.
- Šiuo Onkyo Corporation deklaruoja, kad šis TX-NR646 atitinka esminius reikalavimus ir kitas 1999/5/EB Direktivos nuostatas.
- A Onkyo Corporation ezzenel kijelenti, hogy a TX-NR646 típusú berendezés teljesíti az alapvető követelményeket és más 1999/5/EK irányelvben meghatározott vonatkozó rendelkezéseket.
- Hierbij verklaart Onkyo Corporation dat het toestel I TX-NR646 in overeenstemming is met de essentiële eisen en de andere relevante bepalingen van richtlijn 1999/5/EG.
- Niniejszym Onkyo Corporation deklaruje że TX-NR646 jest zgodny z zasadniczymi wymaganiami i innymi właściwymi postanowieniami Dyrektywy 1999/5/EC.
- Eu, Onkyo Corporation, declaro que o TX-NR646 cumpre os requisitos

essenciais e outras provisões relevantes da Directiva 1999/5/EC.

- Prin prezenta, Onkyo Corporation, declară că aparatul TX-NR646 este în conformitate cu cerințele esențiale și cu alte prevederi pertinente ale Directivei 1999/5/CE.
- Onkyo Corporation tímto vyhlasuje, že TX-NR646 a splňa základné požiadavky a všetky príslušné ustanovenia Smernice 1999/5/ES.
- Onkyo Corporation izjavlja, da je ta TX-NR646 v skladu z bistvenimi zahtevami in drugimi relevantnimi določili direktive 1999/5/ES.
- Onkyo Corporation vakuuttaa täten että TX-NR646 tyyppinen laite on direktiivin 1999/5/EY oleellisten vaatimusten ja sitä koskevien direktiivin muiden ehtojen mukainen.
- Härmed förklarar Onkyo Corporation att denna TX-NR646 följer de väsentliga kraven och andra relevanta stadgar i Direktiv 1999/5/EC.
- Hér með lýsir Onkyo Corporation því yfir að varan TX-NR646 er í samræmi við grunnkröfur og aðrar kröfur sem gerðar eru í tilskipun 1999/5/EC.
- Onkyo Corporation erklærer herved at denne TX-NR646 er i overensstemmelse med væsentlige krav og andre relevante bestemmelser i direktiv 1999/5/EC.
- Ovime Onkyo Corporation, potvrđuje da je TX-NR646 u suglasnosti sa osnovnim zahtjevima i ostalim relevantnim odredbama Direktive 1999/5/EC.







CONTRIBUTORS BE LIABLE FOR ANY DIRECT, INDIRECT, INCIDENTAL, SPECIAL, EXEMPLARY, OR CONSEQUENTIAL DAMAGES (INCLUDING, BUT NOT LIMITED TO, PROCUREMENT OF SUBSTITUTE GOODS OR SERVICES; LOSS OF USE, DATA, OR PROFITS, OR BUSINESS INTERRUPTION) HOWEVER CAUSED AND ON ANY THEORY OF LIABILITY, WHETHER IN CONTRACT, STRICT LIABILITY, OR TORT (INCLUDING NEGLIGENCE OR OTHERWISE) ARISING IN ANY WAY OUT OF THE USE OF THIS SOFTWARE, EVEN IF ADVISED OF THE POSSIBILITY OF SUCH DAMAGE.

(7) libng
COPYRIGHT NOTICE, DISCLAIMER, AND LICENSE:
If you modify libng you may insert additional notices immediately following this sentence.
This code is released under the libng license.

libng versions 1.2.6, August 15, 2004, through 1.4.0, January 3, 2010, are Copyright (c) 2004, 2006-2007 Glenn Randers-Pehrson, and are distributed according to the same disclaimer and license as libpng-1.2.5 with the following individual added to the list of Contributing Authors:

Cosmin Truta
libng versions 1.0.7, July 1, 2000, through 1.2.5 - October 3, 2002, are Copyright (c) 2000-2002 Glenn Randers-Pehrson, and are distributed according to the same disclaimer and license as libpng-1.0.6 with the following individuals added to the list of Contributing Authors:
Simon-Pierre Cadieux
Eric S. Raymond
Gilles Vollant

and with the following additions to the disclaimer:
There is no warranty against interference with your enjoyment of the library or against infringement. There is no warranty that our efforts or the library will fulfill any of your particular purposes or needs. This library is provided with all faults, and the entire risk of satisfactory quality, performance, accuracy, and effort is on the user.

libng versions 0.97, January 1998, through 1.0.6, March 20, 2000, are Copyright (c) 1998, 1999 Glenn Randers-Pehrson, and are distributed according to the same disclaimer and license as libpng-0.96, with the following individuals added to the list of Contributing Authors:

Tom Lane
Glenn Randers-Pehrson
Willem van Schaik
libng versions 0.89, June 1996, through 0.96, May 1997, are Copyright (c) 1996, 1997 Andreas Dilger Distributed according to the same disclaimer and license as libng-0.88, with the following individuals added to the list of Contributing Authors:
John Bowler
Kevin Bracey
Sam Bushell
Magnus Holmgren
Greg Roelofs
Tom Tanner

libng versions 0.5, May 1995, through 0.88, January 1996, are Copyright (c) 1995, 1996 Guy Eric Salhat, Group 42, Inc. For the purposes of this copyright and license, "Contributing Authors" is defined as the following set of individuals:
Andreas Dilger
Dave Martindale
Guy Eric Salhat
Paul Schmitz
Tim Wegner

The PNG Reference Library is supplied "AS IS". The contributing Authors and Group 42, Inc. disclaim all warranties, expressed or implied, including, without limitation, the warranties of merchantability and of fitness for any purpose. The Contributing Authors and Group 42, Inc. assume no liability for direct, indirect, incidental, special, exemplary, or consequential damages, which may result from the use of the PNG Reference Library, even if advised of the possibility of such damage.
Permission is hereby granted to use, copy, modify, and distribute this source code, or portions thereof, for any purpose, without fee, subject to the following restrictions:

1. The origin of this source code must not be misrepresented.
Altered versions must be plainly marked as such and must not be misrepresented as being the original source.
This Copyright notice may not be removed or altered from any source or altered source distribution.
The Contributing Authors and Group 42, Inc. specifically permit, without fee, and encourage the use of this source code as a component to supporting the PNG file format in commercial products. If you use this source code in a product, acknowledgment is not required but would be appreciated.

(8) libvorbis
Copyright (c) 2002-2004 Xiph.org Foundation
Redistribution and use in source and binary forms, with or without modification, are permitted provided that the following conditions are met:
- Redistributions of source code must retain the above copyright notice, this list of conditions and the following disclaimer.
- Redistributions in binary form must reproduce the above copyright notice, this list of conditions and the following disclaimer in the documentation and/or other materials provided with the distribution.

Neither the name of the Xiph.org Foundation nor the names of its contributors may be used to endorse or promote products derived from this software without specific prior written permission.
THIS SOFTWARE IS PROVIDED BY THE COPYRIGHT HOLDERS AND CONTRIBUTORS "AS IS" AND ANY EXPRESS OR IMPLIED WARRANTIES, INCLUDING, BUT NOT LIMITED TO, THE IMPLIED WARRANTIES OF MERCHANTABILITY AND FITNESS FOR A PARTICULAR PURPOSE ARE DISCLAIMED. IN NO EVENT SHALL THE FOUNDATION OR CONTRIBUTORS BE LIABLE FOR ANY DIRECT, INDIRECT, INCIDENTAL, SPECIAL, EXEMPLARY, OR CONSEQUENTIAL DAMAGES (INCLUDING, BUT NOT LIMITED TO, PROCUREMENT OF SUBSTITUTE GOODS OR SERVICES; LOSS OF USE, DATA, OR PROFITS, OR BUSINESS INTERRUPTION) HOWEVER CAUSED AND ON ANY THEORY OF LIABILITY, WHETHER IN CONTRACT, STRICT LIABILITY, OR TORT (INCLUDING NEGLIGENCE OR OTHERWISE) ARISING IN ANY WAY OUT OF THE USE OF THIS SOFTWARE, EVEN IF ADVISED OF THE POSSIBILITY OF SUCH DAMAGE.

(9) ntp
This file is automatically generated from html/copyright.html
Copyright Notice
jrg "Come me." says Dohy sheepishly
Last update: 20:31 UTC Saturday, January 06, 2007

The following copyright notice applies to all files collectively called the Network Time Protocol Version 4 Distribution. Unless specifically declared otherwise in an individual file, this notice applies as if the text was explicitly included in the file.
Copyright (c) David L. Mills 1992-2007
Permission to use, copy, modify, and distribute this software and its documentation for any purpose with or without fee is hereby granted, provided that the above copyright notice appears in all copies and that both the copyright notice and this permission notice appear in supporting documentation, and that the name University of Delaware not be used in advertising or publicity pertaining to distribution of the software without specific, written prior permission. The University of Delaware makes no representations about the suitability this software for any purpose. It is provided "as is" without express or implied warranty. The following individuals contributed in part to the Network Time Protocol Distribution Version 4 and are acknowledged as authors of this work.

- [1]Mark Andrews <mark\_andrews@ac.org> - Leitch atomic clock controller
[2]Bernd Altmeier <altmeier@atsoft.de> - hqf Elektronik serial line and PCI-bus devices
[3]Vivraj Bais <vbais@mailman1.intel.com> and [4]Clayton Kirkwood <kirkwood@striderfirm.intel.com> port to WindowsNT 3.5
[5]Michael Barone <michael.barone@lmco.com> - GPSVME fixes
[6]Jean-Francois Boudreau <Jean-Francois.Boudreau@viagenie.gc.ca> - IPv6 support
[7]Karl Berry <karl@owl.HQ.leaf.com> - syslog to file option
[8]Greg Brackley <greg.brackley@bigfoot.com> - Major rework of WINNT port. Clean up recvbuf and isoginal code into separate modules.
[9]Marc Brett <Marc.Brett@westgeo.com> - Magnavox GPS clock driver
[10]Piete Brooks <Piete.Brooks@cl.cam.ac.uk> - MSF clock driver, Trimble PARSE support
[11]Reg Clemens <reg@dwf.com> - Oncore driver (Current maintainer)
[12]Steve Cliff <cliff@ml.csiro.au> - OMEGA clock driver
[13]Casey Cullen <ccullen@herald.usask.ca> - v1Work (Tomado) port and help with target configuration
[14]Sven Dietrich <svet\_dietrich@trible.com> - Palisade reference clock driver, NT adj. residuals, integrated Greg's Winnt port.
[15]John A. Dundas III <dundas@salt.jpl.nasa.gov> - Apple AUX port
[16]Torsten Duwe <duwe@imm04.informatik.uni-erlangen.de> - Linux port
[17]Dennis Ferguson <dennis@mrbill.canet.ca> - foundation code for NTP Version 2 as specified in RFC-1119
[18]John Hay <jhay@comtek.csir.co.za> - IPv6 support and testing
[19]Glenn Herold <gherold@herald.usask.ca> - G05E clock driver
[20]Mike Iglesias <miglesias@uci.edu> - DEC Alpha port
[21]Jim Jagielski <jim@jagubox.gsfic.nasa.gov> - AUX port
[22]Jeff Johnson <jbj@chatham.usdesign.com> - massive prototyping overhaul
[23]Hans Lambermont <hans.lambermont@nl.origin-it.com> or [24]-H.Lambermont@ghello.nl - ntpswep
[25]Poul-Henning Kamp <poul@FreeBSD.ORG> - Oncore driver (Original author)
[26]Louis A. Marmatos <louie@ghl.uiu.edu> - MD5-based authentication
[27]Jeffrey Mogul <mogul@ga.dec.com> - ntptrace utility
[28]Tom Moore <tmooore@level.daytonoh.nrcr.com> - i386 svr4 port
[29]Kamal A Mostafa <kamal@whence.com> - SCO OpenServer port
[30]Derek Mulcahy <derek@toybox.demon.co.uk> and [41]Damon Hart-Davis <d@hd.org> - ARCRON MSF clock driver
[42]Rainer Pruy <Rainer.Pruy@informatik.uni-erlangen.de> - monitoring/trap scripts, statistics file handling
[43]Dirc Richards <dirc@z3.dec.com> - Digital UNIX V4.0 port
[44]Witold Sanchcz <wsanchez@apple.com> - additional support for NetInfo
[45]Nick Sayer <nrsapp@quack.kfup.com> - SunOS streams modules
[46]Jack Sasportas <jack@innovativeinternet.com> - Saved A Lot of space on the stuff in the html/pic/ subdirectory
[47]Ray Schmitzler <schmitz@unipress.com> - Uniware 1 port
[48]Michael Shields <shields@tembel.org> - USNO clock driver
[49]Jeff Steinman <js@pebbles.jpl.nasa.gov> - Datum P15 clock driver
[50]Jeffrey Stern <stern@nytes.com> - GNU automake/autocfgure makeover, various other bits (see the ChangeLog)
[51]Kenneth Stone <ken@stdh.hp.com> - HP-UX port
[52]Aji Thyagarajan <aji@eee.udel.edu> - IP multicast/fanycast support
[53]Tomoko TSURUOKA <tsuruoka@nc.tukouka-u.ac.jp> - TRAK clock driver
[54]Paul A Vivix <vivix@vivx.com> - True Time GPS driver, generic True Time clock driver
[55]Ulrich Windl <Ulrich.Windl@rz.uni-regensburg.de> - corrected and validated HTML documents according to the HTML DTD
References
mailto: mark\_andrews@ac.org
mailto: altmeier@atsoft.de
mailto: vbais@mailman1.intel.com
mailto: kirkwood@striderfirm.intel.com
mailto: michael.barone@lmco.com
mailto: Jean-Francois.Boudreau@viagenie.gc.ca
mailto: karl@owl.HQ.leaf.com
mailto: greg.brackley@bigfoot.com
mailto: Marc.Brett@westgeo.com
mailto: Piete.Brooks@cl.cam.ac.uk
mailto: reg@dwf.com
mailto: cliff@ml.csiro.au
mailto: casey@cscc.co.za
mailto: Sven\_Dietrich@trible.COM
mailto: dundas@salt.jpl.nasa.gov
mailto: duwe@imm04.informatik.uni-erlangen.de
mailto: dennis@mrbill.canet.ca
mailto: jhay@comtek.csir.co.za
mailto: glenn@herald.usask.ca
mailto: miglesias@uci.edu
mailto: jagubox.gsfic.nasa.gov
mailto: jim@jagubox.gsfic.nasa.gov
mailto: jbj@chatham.usdesign.com
mailto: Hans.Lambermont@nl.origin-it.com
mailto: H.Lambermont@ghello.nl
mailto: phk@FreeBSD.ORG
http://www4.informatik.uni-erlangen.de/%7ekardel
mailto: karde(at)ntp(dot)org
mailto: jones@hermes.chpc.utexas.edu
mailto: dkatz@cisco.com
mailto: paul@pebbles.jpl.nasa.gov
mailto: lindholm@ucsb.ca
mailto: lindholm@ucsb.ca
mailto: louie@ni.umd.edu
mailto: thorinn@dku.dk
mailto: mayer@ntp.org
mailto: mills@udel.edu

- mailto: moeller@gwdg1.dnet.gwdg.de
mailto: mogula@ga.dec.com
mailto: tmooore@level.daytonoh.nrcr.com
mailto: kamal@whence.com
mailto: derek@toybox.demon.co.uk
mailto: d@hd.org
mailto: Rainer.Pruy@informatik.uni-erlangen.de
mailto: dirc@z3.dec.com
mailto: wsanchez@apple.com
mailto: mrsapp@quack.kfu.com
mailto: jack@innovativeinternet.com
mailto: schmitz@unipress.com
mailto: shields@tembel.org
mailto: pebbles.jpl.nasa.gov
mailto: harlan@pfcs.com
mailto: ken@stdh.hp.com
mailto: aji@eee.udel.edu
mailto: tsuruoka@nc.tukouka-u.ac.jp
mailto: vivix@vivx.com
mailto: Ulrich.Windl@rz.uni-regensburg.de

(10) OpenSSL
LICENSE ISSUES
=====
This OpenSSL toolkit stays under a dual license, i.e. both the conditions of the OpenSSL License and the original SSLeay license apply to the toolkit. See below for the actual license texts. Actually both licenses are BSD-style Open Source licenses. In case of any license issues related to OpenSSL, please contact openssl-core@openssl.org.
OpenSSL License
-----
Copyright (c) 1998-2007 The OpenSSL Project. All rights reserved.
Redistribution and use in source and binary forms, with or without modification, are permitted provided that the following conditions are met:
1. Redistributions of source code must retain the above copyright notice, this list of conditions and the following disclaimer.
2. Redistributions in binary form must reproduce the above copyright notice, this list of conditions and the following disclaimer in the documentation and/or other materials provided with the distribution.
All advertising materials mentioning features or use of this software must display the following acknowledgment:
"This product includes software developed by the OpenSSL Project for use in the OpenSSL Toolkit. (http://www.openssl.org/)"
The names "OpenSSL Toolkit" and "OpenSSL Project" must not be used to endorse or promote products derived from this software without prior written permission. For written permission, please contact openssl-core@openssl.org.
Products derived from this software may not be called "OpenSSL" nor may "OpenSSL" appear in their names without prior written permission of the OpenSSL Project.
Redistributions of any form whatsoever must retain the following acknowledgment:
"This product includes software developed by the OpenSSL Project for use in the OpenSSL Toolkit"
(http://www.openssl.org/)"
THIS SOFTWARE IS PROVIDED BY THE OPENSSL PROJECT "AS IS" AND ANY EXPRESSED OR IMPLIED WARRANTIES, INCLUDING, BUT NOT LIMITED TO, THE IMPLIED WARRANTIES OF MERCHANTABILITY AND FITNESS FOR A PARTICULAR PURPOSE ARE DISCLAIMED. IN NO EVENT SHALL THE OPENSSL PROJECT OR ITS CONTRIBUTORS BE LIABLE FOR ANY DIRECT, INDIRECT, INCIDENTAL, SPECIAL, EXEMPLARY, OR CONSEQUENTIAL DAMAGES (INCLUDING, BUT NOT LIMITED TO, PROCUREMENT OF SUBSTITUTE GOODS OR SERVICES; LOSS OF USE, DATA, OR PROFITS, OR BUSINESS INTERRUPTION) HOWEVER CAUSED AND ON ANY THEORY OF LIABILITY, WHETHER IN CONTRACT, STRICT LIABILITY, OR TORT (INCLUDING NEGLIGENCE OR OTHERWISE) ARISING IN ANY WAY OUT OF THE USE OF THIS SOFTWARE, EVEN IF ADVISED OF THE POSSIBILITY OF SUCH DAMAGE.

-----
This product includes cryptographic software written by Eric Young (eay@cryptsoft.com). This product includes software written by Tim Hudson (tjh@cryptsoft.com).
Original SSLeay License
-----
Copyright (C) 1995-1998 Eric Young (eay@cryptsoft.com) All rights reserved.
This package is an SSL implementation written by Eric Young (eay@cryptsoft.com).

This package is free for commercial and non-commercial use so long as the following conditions are adhered to. The following conditions apply to all code found in this distribution, be it the RSA, RSA, IAH, DES, etc., code; not just the SSL code. The SSL documentation included with this distribution is covered by the same copyright terms except that the holder is Tim Hudson (tjh@cryptsoft.com).
Copyright remains Eric Young's, and as such any Copyright notices in the code are not to be removed.
If this package is used in a product, Eric Young should be given attribution as the author of the parts of the library used. This can be in the form of a textual message at program startup or in documentation (online or textual) provided with the package.
Redistribution and use in source and binary forms, with or without modification, are permitted provided that the following conditions are met:
1. Redistributions of source code must retain the copyright notice, this list of conditions and the following disclaimer.
2. Redistributions in binary form must reproduce the above copyright notice, this list of conditions and the following disclaimer in the documentation and/or other materials provided with the distribution.
All advertising materials mentioning features or use of this software must display the following acknowledgement: "Eric Young (eay@cryptsoft.com)"
The word "cryptographic" can be left out of the routines from the library being used are not cryptographic related :-).
If you include any Windows specific code (or a derivative thereof) from the apps directory (application code) you must include an acknowledgement: "This product includes software written by Tim Hudson (tjh@cryptsoft.com)"
THIS SOFTWARE IS PROVIDED BY ERIC YOUNG "AS IS" AND ANY EXPRESS OR IMPLIED WARRANTIES, INCLUDING, BUT NOT LIMITED TO, THE IMPLIED WARRANTIES OF MERCHANTABILITY AND FITNESS FOR A PARTICULAR PURPOSE ARE DISCLAIMED. IN NO EVENT SHALL THE AUTHOR OR CONTRIBUTORS BE LIABLE FOR ANY DIRECT, INDIRECT, INCIDENTAL, SPECIAL, EXEMPLARY, OR CONSEQUENTIAL DAMAGES (INCLUDING, BUT NOT LIMITED TO, PROCUREMENT OF SUBSTITUTE GOODS OR SERVICES; LOSS OF USE, DATA, OR PROFITS, OR BUSINESS INTERRUPTION) HOWEVER CAUSED AND ON ANY THEORY OF LIABILITY, WHETHER IN CONTRACT, STRICT LIABILITY, OR TORT (INCLUDING NEGLIGENCE OR OTHERWISE) ARISING IN ANY WAY OUT OF THE USE OF THIS SOFTWARE, EVEN IF ADVISED OF THE POSSIBILITY OF SUCH DAMAGE.

-----
(11) popt



Any subroutines or modules supplied by You and linked into the Source Code or Executable Files this Work shall not be considered part of this Work and will not be subject to the terms of this License.

Patent License. Subject to the terms and conditions of this License, each Author hereby grants to You a perpetual, worldwide, non-exclusive, no-charge, royalty-free, irrevocable (except as stated in this section) patent license to make, have made, use, import, and otherwise transfer the Work.

Restrictions. The license granted in Section 3 above is expressly made subject to and limited by the following restrictions:

- You agree not to remove any of the original copyright, patent, trademark, and attribution notices and associated disclaimers that may appear in the Source Code or Executable Files.
- You agree not to advertise or in any way imply that this Work is a product of Your own.
- The name of the Author may not be used to endorse or promote products derived from the Work without the prior written consent of the Author.
- You agree not to sell, lease, or rent any part of the Work. This does not restrict you from including the Work or any part of the Work inside a larger software distribution that itself is being sold. The Work by itself, though, cannot be sold, leased or rented.
- You may distribute the Executable Files and Source Code only under the terms of this License, and You must include a copy of, or the Uniform Resource Identifier for, this License with every copy of the Executable Files or Source Code You distribute and ensure that anyone receiving such Executable Files and Source Code agrees that the terms of this License apply to such Executable Files and/or Source Code. You may not offer or impose any terms on the Work that alter or restrict the terms of this License or the recipient's exercise of the rights granted hereunder. You may not sublicense the Work. You must keep intact all notices that refer to this License and to the disclaimer of warranties. You may not distribute the Executable Files or Source Code with any technological measures that control access to or use of the Work in a manner inconsistent with the terms of this License.
- You agree not to use the Work for illegal, immoral or improper purposes, or on pages containing illegal, immoral or improper material. The Work is subject to applicable export laws. You agree to comply with all such laws and regulations that may apply to the Work after the receipt of the Work.

Representations, Warranties and Disclaimer. THIS WORK IS PROVIDED "AS IS", "WHERE IS" AND "AS AVAILABLE", WITHOUT ANY EXPRESS OR IMPLIED WARRANTIES OR CONDITIONS OR GUARANTEES. YOU, THE USER, ASSUME ALL RISK IN ITS USE, INCLUDING COPYRIGHT INFRINGEMENT, PATENT INFRINGEMENT, SUITABILITY, ETC. AUTHOR EXPRESSLY DISCLAIMS ALL EXPRESS, IMPLIED OR STATUTORY WARRANTIES OR CONDITIONS, INCLUDING WITHOUT LIMITATION, WARRANTIES OR CONDITIONS OF MERCHANTABILITY, MERCHANTABLE QUALITY OR FITNESS FOR A PARTICULAR PURPOSE, OR ANY WARRANTY OF TITLE OR NON-INFRINGEMENT, OR THAT THE WORK (OR ANY PORTION THEREOF) IS CORRECT, USEFUL, BUG-FREE OR FREE OF VIRUSES. YOU MUST PASS THIS DISCLAIMER ON WHENEVER YOU DISTRIBUTE THE WORK OR DERIVATIVE WORKS.

Indemnity. You agree to defend, indemnify and hold harmless the Author and the Publisher from and against any claims, suits, losses, damages, liabilities, costs, and expenses (including reasonable legal or attorneys' fees) resulting from or relating to any use of the Work by You.

Limitation on Liability. EXCEPT TO THE EXTENT REQUIRED BY APPLICABLE LAW, IN NO EVENT WILL THE AUTHOR OR THE PUBLISHER BE LIABLE TO YOU ON ANY LEGAL THEORY FOR ANY SPECIAL, INCIDENTAL, CONSEQUENTIAL, PUNITIVE OR EXEMPLARY DAMAGES ARISING OUT OF THIS LICENSE OR THE USE OF THE WORK OR OTHERWISE, EVEN IF THE AUTHOR OR THE PUBLISHER HAS BEEN ADVISED OF THE POSSIBILITY OF SUCH DAMAGES.

Termination.

- This License and the rights granted hereunder will terminate automatically upon any breach by You of any term of this License. If, however, you or your licensee or other authorized Derivative Works from You under this License, however, will not have their licenses terminated provided such individuals or entities remain in full compliance with those licenses. Sections 1, 2, 6, 7, 8, 9, 10 and 11 will survive any termination of this License.
- If you bring a copyright, trademark, patent or any other infringement claim against any contributor over infringements you claim are made by the Work, your License from such contributor to the Work ends automatically.
- Subject to the above terms and conditions, this License is perpetual (for the duration of the applicable copyright in the Work), notwithstanding the above, the Author reserves the right to release the Work under different license terms or to stop distributing the Work at any time; provided, however that any such election will not serve to withdraw this License (or any other license that has been, or is required to be, granted under the terms of this License), and this License will continue in full force and effect unless terminated as stated above.

Publisher. The parties hereby confirm that the Publisher shall not, under any circumstances, be responsible for and shall not have any liability in respect of the subject matter of this License. The Publisher makes no warranty whatsoever in connection with the Work and shall not be liable to You or any party on any legal theory for any damages whatsoever, including without limitation any general, special, incidental or consequential damages arising in connection to this license. The Publisher reserves the right to cease making the Work available to You at any time without notice.

Miscellaneous

- This License shall be governed by the laws of the location of the head office of the Author or if the Author is an individual, the laws of location of the principal place of residence of the Author.
- If any provision of this License is invalid or unenforceable under applicable law, it shall not affect the validity or enforceability of the remainder of the terms of this License, and without further action by the parties to this License, such provision shall be reformed to the minimum extent necessary to make such provision valid and enforceable.
- No term or provision of this License shall be deemed waived and no breach consented to unless such waiver or consent shall be in writing and signed by the party to be charged with such waiver or consent.
- This License constitutes the entire agreement between the parties with respect to the Work licensed herein. There are no understandings, agreements or representations with respect to the Work not specified herein. The Author shall not be bound by any additional provisions that may appear in any communication from You. This License may not be modified without the mutual written agreement of the Author and You.

(19) Tremolo  
<http://wss.co.uk/pinknoise/tremolo>  
 Copyright (C) 2002-2009 Xiph.org Foundation Changes Copyright (C) 2009-2010 Robin Watts for Pinknoise Productions Ltd  
 Redistribution and use in source and binary forms, with or without modification, are permitted provided that the following conditions are met:

- Redistributions of source code must retain the above copyright notice, this list of conditions and the following disclaimer.
- Redistributions in binary form must reproduce the above copyright notice, this list of conditions and the following disclaimer in the documentation and/or other materials provided with the distribution.
- Neither the name of the Xiph.org Foundation nor the names of its contributors may be used to endorse or promote products derived from this software without specific prior written permission.

THIS SOFTWARE IS PROVIDED BY THE COPYRIGHT HOLDERS AND CONTRIBUTORS "AS IS" AND ANY EXPRESS OR IMPLIED WARRANTIES, INCLUDING, BUT NOT LIMITED TO, THE IMPLIED WARRANTIES OF MERCHANTABILITY AND FITNESS FOR A PARTICULAR PURPOSE ARE DISCLAIMED. IN NO EVENT SHALL THE FOUNDATION OR CONTRIBUTORS BE LIABLE FOR ANY DIRECT, INDIRECT, INCIDENTAL, SPECIAL, EXEMPLARY, OR CONSEQUENTIAL DAMAGES (INCLUDING, BUT NOT LIMITED TO, PROCUREMENT OF SUBSTITUTE GOODS OR SERVICES; LOSS OF USE, DATA, OR PROFITS, OR BUSINESS INTERRUPTION) HOWEVER CAUSED AND ON ANY THEORY OF LIABILITY, WHETHER IN CONTRACT, STRICT LIABILITY, OR TORT (INCLUDING NEGLIGENCE OR OTHERWISE) ARISING IN ANY WAY OUT OF THE USE OF THIS SOFTWARE, EVEN IF ADVISED OF THE POSSIBILITY OF SUCH DAMAGE.

(20) Tremor  
<http://wiki.xiph.org/index.php/Tremor>

Copyright (c) 2002, Xiph.org Foundation  
 Redistribution and use in source and binary forms, with or without modification, are permitted provided that the following conditions are met:

- Redistributions of source code must retain the above copyright notice, this list of conditions and the following disclaimer.
- Redistributions in binary form must reproduce the above copyright notice, this list of conditions and the following disclaimer in the documentation and/or other materials provided with the distribution.
- Neither the name of the Xiph.org Foundation nor the names of its contributors may be used to endorse or promote products derived from this software without specific prior written permission.

THIS SOFTWARE IS PROVIDED BY THE COPYRIGHT HOLDERS AND CONTRIBUTORS "AS IS" AND ANY EXPRESS OR IMPLIED WARRANTIES, INCLUDING, BUT NOT LIMITED TO, THE IMPLIED WARRANTIES OF MERCHANTABILITY AND FITNESS FOR A PARTICULAR PURPOSE ARE DISCLAIMED. IN NO EVENT SHALL THE FOUNDATION OR CONTRIBUTORS BE LIABLE FOR ANY DIRECT, INDIRECT, INCIDENTAL, SPECIAL, EXEMPLARY, OR CONSEQUENTIAL DAMAGES (INCLUDING, BUT NOT LIMITED TO, PROCUREMENT OF SUBSTITUTE GOODS OR SERVICES; LOSS OF USE, DATA, OR PROFITS, OR BUSINESS INTERRUPTION) HOWEVER CAUSED AND ON ANY THEORY OF LIABILITY, WHETHER IN CONTRACT, STRICT LIABILITY, OR TORT (INCLUDING NEGLIGENCE OR OTHERWISE) ARISING IN ANY WAY OUT OF THE USE OF THIS SOFTWARE, EVEN IF ADVISED OF THE POSSIBILITY OF SUCH DAMAGE.

(21) Mersenne Twister  
<http://www.math.sci.hiroshima-u.ac.jp/~m-mat/MT/MT2002/CODES/mt19937ar.c>  
 Copyright (C) 1997 - 2002, Makoto Matsumoto and Takju Nishimura,  
 All rights reserved.  
 Redistribution and use in source and binary forms, with or without modification, are permitted provided that the following conditions are met:

Redistributions of source code must retain the above copyright notice, this list of conditions and the following disclaimer.

Redistributions in binary form must reproduce the above copyright notice, this list of conditions and the following disclaimer in the documentation and/or other materials provided with the distribution.

The names of its contributors may not be used to endorse or promote products derived from this software without specific prior written permission.

THIS SOFTWARE IS PROVIDED BY THE COPYRIGHT HOLDERS AND CONTRIBUTORS "AS IS" AND ANY EXPRESS OR IMPLIED WARRANTIES, INCLUDING, BUT NOT LIMITED TO, THE IMPLIED WARRANTIES OF MERCHANTABILITY AND FITNESS FOR A PARTICULAR PURPOSE ARE DISCLAIMED. IN NO EVENT SHALL THE COPYRIGHT OWNER OR CONTRIBUTORS BE LIABLE FOR ANY DIRECT, INDIRECT, INCIDENTAL, SPECIAL, EXEMPLARY, OR CONSEQUENTIAL DAMAGES (INCLUDING, BUT NOT LIMITED TO, PROCUREMENT OF SUBSTITUTE GOODS OR SERVICES; LOSS OF USE, DATA, OR PROFITS, OR BUSINESS INTERRUPTION) HOWEVER CAUSED AND ON ANY THEORY OF LIABILITY, WHETHER IN CONTRACT, STRICT LIABILITY, OR TORT (INCLUDING NEGLIGENCE OR OTHERWISE) ARISING IN ANY WAY OUT OF THE USE OF THIS SOFTWARE, EVEN IF ADVISED OF THE POSSIBILITY OF SUCH DAMAGE.

(22) curl  
<http://curl.haxx.se>  
 COPYRIGHT AND PERMISSION NOTICE  
 Copyright (c) 1996 - 2011, Daniel Stenberg, <daniel@haxx.se>. All rights reserved.  
 Permission to use, copy, modify, and distribute this software for any purpose with or without fee is hereby granted, provided that the above copyright notice and this permission notice appear in all copies.

THE SOFTWARE IS PROVIDED "AS IS", WITHOUT WARRANTY OF ANY KIND, EXPRESS OR IMPLIED, INCLUDING BUT NOT LIMITED TO THE WARRANTIES OF MERCHANTABILITY, FITNESS FOR A PARTICULAR PURPOSE AND NONINFRINGEMENT OF THIRD PARTY RIGHTS. IN NO EVENT SHALL THE AUTHORS OR COPYRIGHT HOLDERS BE LIABLE FOR ANY CLAIM, DAMAGES OR OTHER LIABILITY, WHETHER IN AN ACTION OF CONTRACT, TORT OR OTHERWISE, ARISING FROM, OUT OF OR IN CONNECTION WITH THE SOFTWARE OR THE USE OR OTHER DEALINGS IN THE SOFTWARE.

Except as contained in this notice, the name of a copyright holder shall not be used in advertising or otherwise to promote the sale, use or other dealings in this Software without prior written authorization of the copyright holder.

(23) c-ares  
<http://c-ares.haxx.se>  
 Copyright 1998 by the Massachusetts Institute of Technology.  
 Permission to use, copy, modify, and distribute this software and its documentation for any purpose and without fee is hereby granted, provided that the above copyright notice appear in all copies and that both that copyright notice and this permission notice appear in supporting documentation, and that the name of M.I.T. not be used in advertising or publicity pertaining to distribution of the software without specific, written prior permission. M.I.T. makes no representations about the suitability of this software for any purpose. It is provided "as is" without express or implied warranty.

(24) LZ4  
 Copyright (c) 2011-2014, Yann Collet All rights reserved.  
 Redistribution and use in source and binary forms, with or without modification, are permitted provided that the following conditions are met:

- \* Redistributions of source code must retain the above copyright notice, this list of conditions and the following disclaimer.
- \* Redistributions in binary form must reproduce the above copyright notice, this list of conditions and the following disclaimer in the documentation and/or other materials provided with the distribution.

THIS SOFTWARE IS PROVIDED BY THE COPYRIGHT HOLDERS AND CONTRIBUTORS "AS IS" AND ANY EXPRESS OR IMPLIED WARRANTIES, INCLUDING, BUT NOT LIMITED TO, THE IMPLIED WARRANTIES OF MERCHANTABILITY AND FITNESS FOR A PARTICULAR PURPOSE ARE DISCLAIMED. IN NO EVENT SHALL THE COPYRIGHT HOLDER OR CONTRIBUTORS BE LIABLE FOR ANY DIRECT, INDIRECT, INCIDENTAL, SPECIAL, EXEMPLARY, OR CONSEQUENTIAL DAMAGES (INCLUDING, BUT NOT LIMITED TO, PROCUREMENT OF SUBSTITUTE GOODS OR SERVICES; LOSS OF USE, DATA, OR PROFITS, OR BUSINESS INTERRUPTION) HOWEVER CAUSED AND ON ANY THEORY OF LIABILITY, WHETHER IN CONTRACT, STRICT LIABILITY, OR TORT (INCLUDING NEGLIGENCE OR OTHERWISE) ARISING IN ANY WAY OUT OF THE USE OF THIS SOFTWARE, EVEN IF ADVISED OF THE POSSIBILITY OF SUCH DAMAGE.

## License and Trademark Information



Manufactured under license from Dolby Laboratories. Dolby, Dolby Atmos, Dolby Surround and the double-D symbol are trademarks of Dolby Laboratories.



For DTS patents, see <http://patents.dts.com>. Manufactured under license from DTS, Inc. DTS, the Symbol, DTS in combination with the Symbol, the DTS-HD logo, and DTS-HD Master Audio are registered trademarks or trademarks of DTS, Inc. in the United States and/or other countries. © DTS, Inc. All Rights Reserved.



"CINEMA FILTER" and "CINEMA FILTER (logo)" are trademarks of Onkyo Corporation.



The terms HDMI and HDMI High-Definition Multimedia Interface, and the HDMI Logo are trademarks or registered trademarks of HDMI Licensing LLC in the United States and other countries.



The Wi-Fi CERTIFIED Logo is a certification mark of the Wi-Fi Alliance®.



AirPlay, iPad, iPhone, and iPod touch are trademarks of Apple Inc., registered in the U.S. and other countries.

iPad Air and iPad mini are trademarks of Apple Inc.

"Made for iPod", "Made for iPhone" and "Made for iPad" mean that an electronic accessory has been designed to connect specifically to iPod, iPhone, or iPad, respectively, and has been certified by the developer to meet Apple performance standards. Apple is not responsible for the operation of this device or its compliance with safety and regulatory standards.

Please note that the use of this accessory with iPod, iPhone or iPad may affect wireless performance.

AirPlay works with iPhone, iPad, and iPod touch with iOS 4.3.3 or later, Mac with OS X Mountain Lion or later, and PC with iTunes 10.2.2 or later.

Apple, Apple TV and Safari are trademarks of Apple Inc., registered in the U.S. and other countries.



The Bluetooth® word mark and logos are registered trademarks owned by Bluetooth SIG, Inc. and any use of such marks by Onkyo is under license. Other trademarks and trade names are those of their respective owners.

Onkyo does not guarantee Bluetooth compatibility between the AV receiver and all Bluetooth-enabled devices.

For compatibility between the AV receiver and another device with Bluetooth technology, consult the device's documentation and dealer. In some countries, there may be restrictions on using Bluetooth devices. Check with your local authorities.



SIRIUS, XM and all related marks and logos are trademarks of Sirius XM Radio Inc. and its subsidiaries. All rights reserved.

DLNA®, the DLNA Logo and DLNA CERTIFIED® are trademarks, service marks, or certification marks of the Digital Living Network Alliance.

This product is protected by certain intellectual property rights of Microsoft. Use or distribution of such technology outside of this product is prohibited without a license from Microsoft.

Windows and the Windows logo are trademarks of the Microsoft group of companies.

QR Code is a registered trademark of DENSO WAVE INCORPORATED.

"x.v.Color" and "x.v.Color" logo are trademarks of Sony Corporation.

DSD and the Direct Stream Digital logo are trademarks of Sony Corporation.

MPEG Layer-3 audio coding technology licensed from Fraunhofer IIS and Thomson.

AccuEQ, Music Optimizer, RIHD and WRAT are trademarks of Onkyo Corporation.

"All other trademarks are the property of their respective owners."

## DISCLAIMER

Through this device you are able to link to other services or websites which are not under the control of any company which has designed, manufactured or distributed/have distributed this device, and its affiliates (collectively, "Company"). We have no control over the nature, content and availability of those services. The inclusion of any links does not necessarily imply a recommendation or endorse the views expressed within them.

All information, content and services available through this device belong to third parties and are protected by copyright, patent, trademark and/or other intellectual property laws of applicable countries.

The information, content and services provided through this device are for your personal, noncommercial use only. Any information, content or services may not be used in any manner other than previously approved by the appropriate content owner or service

provider.

You may not modify, copy, republish, translate, exploit, create derivative works, upload, post, transmit, sell or distribute in any manner any information, content or services available through this device, unless expressly permitted by the appropriate copyright, patent, trademark and/or other intellectual property owner, including, without limitation, content owner or service provider.

THE CONTENT AND SERVICES AVAILABLE THROUGH THIS DEVICE ARE PROVIDED "AS IS".

COMPANY DOES NOT WARRANT INFORMATION, CONTENT OR SERVICES SO PROVIDED, EITHER EXPRESSLY OR IMPLIEDLY, FOR ANY PURPOSE.





COMPANY EXPRESSLY DISCLAIMS ANY WARRANTIES, EXPRESS OR IMPLIED, INCLUDING BUT NOT LIMITED TO, WARRANTIES OF TITLE, NON-INFRINGEMENT, MERCHANTABILITY OR FITNESS FOR A PARTICULAR PURPOSE.

Company makes no representation or warranty of any kind, express or implied, about the completeness, accuracy, validity, legality, reliability, suitability or availability with respect to the information, content or services available through this device. Company shall not be liable, whether in contract or tort, including negligence and strict liability, for any direct, indirect, special, incidental or consequential damages or any other damages arising out of, or in connection with, any information contained in, or as a result of the use of any content or service by you or any third party, even if Company has been advised of the possibility of such damages, nor shall Company be liable for any third party claims against users of this device or any third party.

In no event shall Company be responsible nor liable for, without limiting the generality of the foregoing, any interruption or suspension of any information, content or service available through this device. Company is neither responsible nor liable for customer service related to the information, content and services available through this device. Any question or request for service relating to the information, content or services should be made directly to the appropriate content owners and services providers.



## Supplied Accessories

-  Indoor FM antenna --- (1)
-  AM loop antenna --- (1)
-  Remote controller (RC-898M) --- (1)  
Batteries (AA/R6) --- (2)
-  Power cord (Taiwanese models) --- (1)
-  Speaker setup microphone --- (1)

\* The number in parenthesis indicates the quantity. On packaging, the letter at the end of the product name indicates the color.

## How to use the remote controller

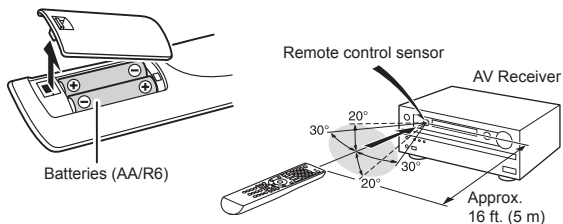

- \* If you do not use the remote controller for a long time, remove the batteries to prevent leakage.
- \* Note that keeping consumed batteries inside may cause corrosion resulting in damage of the remote controller.

# ONKYO

Onkyo Corporation  
Kitahama Chuo Bldg, 2-2-22 Kitahama, Chuo-ku,  
OSAKA 541-0041, JAPAN  
<http://www.onkyo.com/>

### The Americas

Onkyo U.S.A. Corporation  
18 Park Way, Upper Saddle River, N.J. 07458, U.S.A.  
For Dealer, Service, Order and all other Business Inquiries:  
Tel: 201-785-2600 Fax: 201-785-2650  
<http://www.us.onkyo.com/>

For Product Support Team Only:  
1-800-229-1687  
<http://www.us.onkyo.com/>

### Europe

Onkyo Europe Electronics GmbH  
Liegnitzerstrasse 6, 82194 Groebenzell, GERMANY  
Tel: +49-8142-4401-0 Fax: +49-8142-4208-213  
<http://www.eu.onkyo.com/>

### Onkyo Europe Electronics GmbH (UK Branch)

Meridien House, Ground floor, 69 - 71 Clarendon Road,  
Watford, Hertfordshire, WD17 1DS, United Kingdom  
Tel: +44 (0)8712-00-19-96 Fax: +44 (0)8712-00-19-95

### China

Onkyo China Limited (Hong Kong)  
Unit 1033, 10/F, Star House, No 3, Salisbury Road,  
Tsim Sha Tsui Kowloon, Hong Kong.  
Tel: 852-2429-3118 Fax: 852-2428-9039  
<http://www.hk.onkyo.com/>

### Onkyo China PRC (Mainland)

1301, 555 Tower, No.555 West NanJing Road, Jing'an District,  
Shanghai, China 200041,  
Tel: 86-21-52131366 Fax: 86-21-52130396  
<http://www.cn.onkyo.com/>

### Asia, Oceania, Middle East, Africa

Please contact an Onkyo distributor referring to Onkyo  
SUPPORT site.  
<http://www.intl.onkyo.com/support/>

The above-mentioned information is subject to change  
without prior notice.  
Visit the Onkyo web site for the latest update.

SN 29401979

(C) Copyright 2015 Onkyo Corporation Japan. All rights reserved. Onkyo has the Privacy Policy. You can review it at [<http://www.onkyo.com/privacy/>].



\* 2 9 4 0 1 9 7 9 \*

F1502-0